

Stainless Steel Pipe System

Vic-Press™ for Schedule 10S Type 316/316L Stainless Steel



18.11



The Victaulic® PFT510 tool is the only press tool approved for use on the Vic-Press™ for Schedule 10S System.

1.0 PRODUCT DESCRIPTION

Available Sizes:

- ½ – 2"/DN15 – DN50

Maximum Working Pressure:

- Accommodates pressures ranging from full vacuum (29.9 in Hg/760 mm Hg) up to 500 psi/3447 kPa
- Rated up to 300 psi when used with Schedule 5S pipe
- FM Approved to 300 psi/2068 kPa

Application:

- Joins ASTM A312 Schedule 10S Types 316/316L stainless steel pipe
- Recommended on services conveying water, hydrocarbons, water/hydrocarbon mixtures, air (wet/dry/with oil vapors), other gases, vegetable and mineral oils, as well as automotive fluids such as engine oil and transmission fluid within the temperature range of -30°F to +300°F/-34°C to +149°C, depending on service and seal material selected.

Pipe Materials:

- Standard ASTM A312 Schedule 10S Types 316/316L stainless steel pipe

Codes and Requirements:

- Support hanger spacing correspond to ASME B31.1 Power Piping Code, ASME B31.3 Process Piping, and ASME B31.9 Building Services Piping Code.
- Meets ASME requirements and ratings for ANSI Class 150 systems for water, oil, gases and general chemical services
- Meets the requirements of ASME B31.1, B31.3 and B31.9 for Schedule 10S systems
- Request publications [18.16](#), [18.17](#) and [18.18](#) for details.

ALWAYS REFER TO ANY NOTIFICATIONS AT THE END OF THIS DOCUMENT REGARDING PRODUCT INSTALLATION, MAINTENANCE OR SUPPORT.

System No.		Location	
Submitted By		Date	

Spec Section		Paragraph	
Approved		Date	



1.1 PRODUCT DESCRIPTION

Vic-Press™ Joining System for Schedule 10S Type 316/316L Stainless Steel Pipe

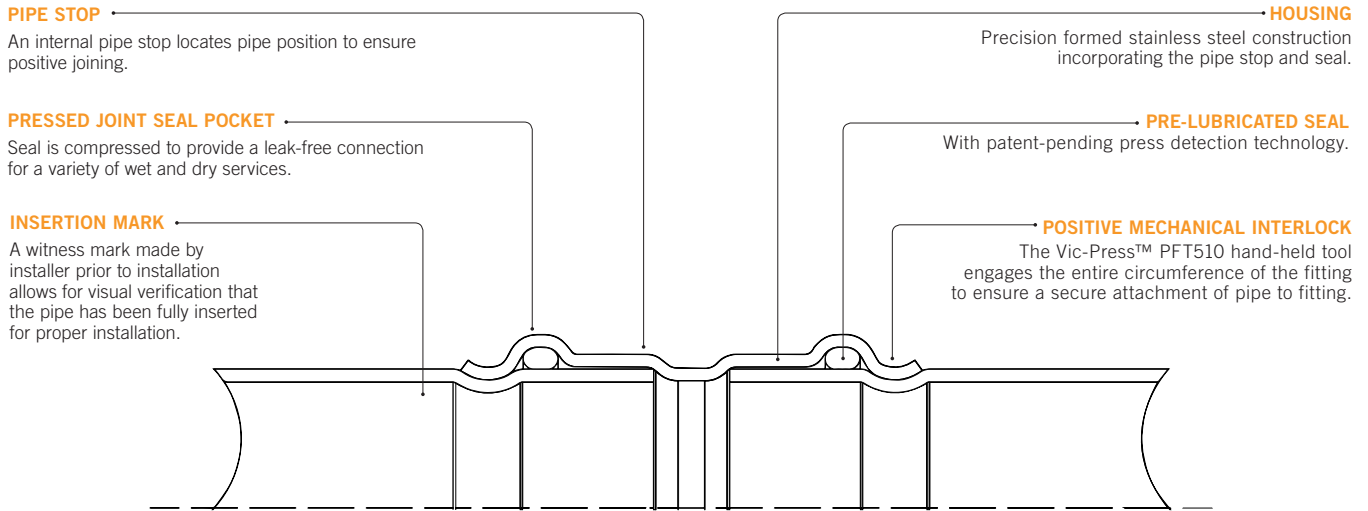

Dimensional Information

- Products in the Vic-Press™ for Schedule 10S system for Type 316/316L stainless steel have unique center-to-end or end-to-end dimensions which incorporate specific, “takeout” dimensions for easy fabrication calculations.
- Use of threaded products employing special features such as probes, escutcheon cups, etc., should be checked to be certain the thread standard and length of insertion are compatible with fitting dimensions.
- Failure to verify dimensional suitability in advance may result in difficulties in assembly.

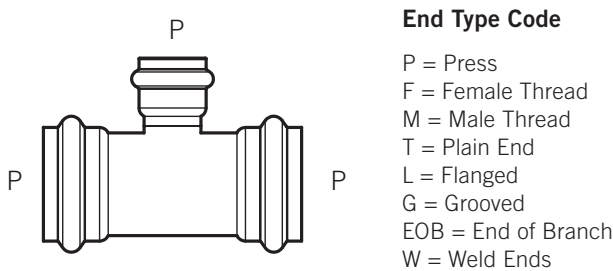

2.0 CERTIFICATION/LISTINGS



NOTES

- See [publication 02.06](#): Victaulic Potable Water Approvals ANSI/NSF for potable water approvals if applicable.
- For complete information on Maritime approvals, visit <https://www.victaulic.com/maritime-approvals/>

3.0 SPECIFICATIONS - MATERIAL

Housing: Made from Type 316L stainless steel.

Threaded Outlets: Made from stainless steel bar, or stainless steel pipe conforming to ASTM A312, Type 316L.

Plain End or Grooved End Products: Stainless steel pipe conforming to ASTM A312, Type 316L.

Style P575 Flange Adapter: ANSI Class 150 or AS 2129 Table E, Type 316L raised face one-piece Type 316L stainless steel flange adapter.

Style P566 Van Stone Flange Adapter: ANSI Class 150 or AS 2129 Table E, carbon steel raised face slip on flange with Type 316 stainless steel stub end.

Style P574 Concentric Reducer: Reducer body made from Type 316 stainless steel, press ends made from Type 316L stainless steel.

Seal:

Victaulic Grade “H” HNBR

HNBR (Two orange stripes color code). Temperature range -20°F to +210°F/-29°C to +98°C. May be specified for hot petroleum/ water mixtures, hydrocarbons, air with oil vapors, vegetable and mineral oils, engine oil, transmission oil. UL Classified in accordance with ANSI/NSF 61 for cold +73°F/+23°C and hot +180°F/+82°C potable water service and ANSI/NSF 372.

Optional Seal: (specify choice¹)

Victaulic Grade “E” EPDM

EPDM (Green stripe color code). Temperature range -30°F to +250°F/-34°C to +121°C. May be specified for hot water service, dilute acids, oil-free air, chemical services. UL Classified in accordance with ANSI/NSF 61 for cold +73°F/+23°C and hot +180°F/+82°C potable water service and ANSI/ NSF 372. **NOT COMPATIBLE FOR USE WITH PETROLEUM OR STEAM SERVICES.**

Victaulic Grade “O” Fluoroelastomer

Fluoroelastomer (Blue stripe color code). Temperature range +20°F to + 300°F/-7°C to +149°C. May be specified for many oxidizing acids, petroleum oils, halogenated hydrocarbons, lubricants, hydraulic fluids, organic liquids and air with hydrocarbons. **NOT COMPATIBLE FOR HOT WATER OR STEAM SERVICES.**

Others

For alternate gasket selection, reference [publication 05.01](#): Victaulic Seal Selection Guide - Elastomeric Seal Construction.

¹ Services listed are General Service Guidelines only. It should be noted that there are services for which these gaskets are not compatible. Reference should always be made to the latest [Victaulic Seal Selection Guide](#) for specific gasket service guidelines and for a listing of services which are not compatible.

NOTE

- Vic-Press™ for Schedule 10S seals are pre-lubricated to further simplify the installation process. To maintain the integrity of the lubrication, components are shipped in factory sealed bags and should remain bagged until ready for use. For more information regarding the lubricant used, please refer to [publication 05.07](#).

4.0 DIMENSIONS

Standard Coupling

Style P507 (P x P)

Working Pressure: 500 psi/3447 kPa



Style P507

Size		Dimensions		Weight
Nominal inches DN	Actual Outside Diameter inches mm	E to E inches mm	U Takeout inches mm	Approximate (Each) lb kg
1/2 DN15	0.840 21.3	2.78 70.6	0.65 16.5	0.2 0.1
3/4 DN20	1.050 26.7	2.78 70.6	0.65 16.5	0.3 0.1
1 DN25	1.315 33.4	3.11 79.0	0.73 18.5	0.5 0.2
1 1/2 DN40	1.900 48.3	3.48 88.4	0.72 18.3	0.7 0.3
2 DN50	2.375 60.3	3.96 100.6	0.71 18.0	1.0 0.5

Slip Coupling

Style P508 (P x P)

Working Pressure: 500 psi/3447 kPa

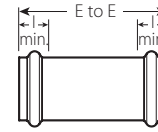

Style P508

Size		Dimensions		Weight
Nominal inches DN	Actual Outside Diameter inches mm	E to E inches mm	I Min. Tube Insert inches mm	Approximate (Each) lb kg
1/2 DN15	0.840 21.3	3.79 96.3	1.06 26.9	0.3 0.1
3/4 DN20	1.050 26.7	3.92 99.6	1.06 26.9	0.4 0.2
1 DN25	1.315 33.4	4.55 115.6	1.19 30.2	0.7 0.3
1 1/2 DN40	1.900 48.3	5.33 135.4	1.38 35.1	1.1 0.5
2 DN50	2.375 60.3	6.18 157.1	1.63 41.4	1.6 0.7

Tee

Style P572 (P x P x P)

Working Pressure: 500 psi/3447 kPa

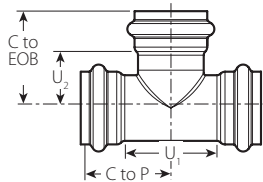

Style P572

Size		Dimensions				Weight
Nominal inches DN	Actual Outside Diameter inches mm	C to P inches mm	U ₁ Takeout inches mm	C to EOB inches mm	U ₂ Takeout inches mm	Approximate (Each) lb kg
1/2 DN15	0.840 21.3	1.71 43.4	1.29 32.8	1.91 48.5	0.84 21.3	0.4 0.2
3/4 DN20	1.050 26.7	2.01 51.1	1.89 48.0	1.93 49.0	0.87 22.1	0.5 0.2
1 DN25	1.315 33.4	2.27 57.7	2.17 55.1	2.24 56.9	1.05 26.7	0.9 0.4
1 1/2 DN40	1.900 48.3	2.72 69.1	2.68 68.1	2.74 69.6	1.37 34.8	1.5 0.7
2 DN50	2.375 60.3	3.21 81.5	3.17 80.5	3.36 85.3	1.73 43.9	2.1 1.0

4.1 DIMENSIONS

Tee with Reducing Branch

Style P573 (P x P x P)

Working Pressure: 500psi/3447 kPa

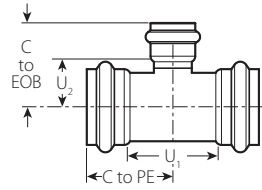

Style P573

Size			Dimensions				Weight		
Nominal inches DN	Actual Outside Diameter inches mm		C to P inches mm	U ₁ Takeout inches mm	C to EOB inches mm	U ₂ Takeout inches mm	Approximate (Each) lb kg		
3/4 DN20	x	3/4	2.01 51.1	1.89 48.0	2.01 51.1	0.95 24.1	0.5 0.2		
		x					1/2	0.840 21.3	0.8 0.4
1 DN25	x	1	2.27 57.7	2.17 55.1	2.14 54.4	1.08 27.4	0.8 0.4		
		x					3/4	1.050 26.7	0.8 0.4
		x					1/2	0.840 21.3	1.00 25.4
1 1/2 DN40	x	1 1/2	2.72 69.1	2.69 68.3	2.44 62.0	1.17 29.7	1.2 0.5		
		x					3/4	1.050 26.7	1.29 0.6
		x					1/2	0.840 21.3	1.34 0.6
		x					1	1.315 33.4	1.34 0.6
		x					3/4	1.050 26.7	1.34 0.6
2 DN50	x	2	3.21 81.5	3.16 80.3	2.67 67.8	1.61 40.9	1.7 0.8		
		x					3/4	1.050 26.7	1.53 0.8
		x					1/2	0.840 21.3	1.53 0.8
		x					1	1.315 33.4	1.58 0.8
		x					3/4	1.050 26.7	1.58 0.8
		x					1 1/2	1.900 48.3	1.60 0.9

4.2 DIMENSIONS

Tee with Threaded Branch²

Style P578 (P x P x F)

Working Pressure: 500psi/3447kPa

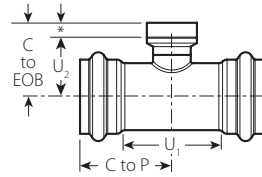

Style P578

*Length of effective thread

Size			Dimensions				Weight
Nominal inches DN	Actual Outside Diameter inches mm		C to P inches mm	U ₁ Takeout inches mm	C to EOB inches mm	U ₂ Takeout inches mm	Approximate (Each) lb kg
1/2 x 1/2 x 1/2 DN15 x DN15 x DN15	0.840	0.840	1.71	1.29	1.46	0.93	0.4
	21.3	21.3	43.4	32.8	37.1	23.6	0.2
3/4 x 3/4 x 1/2 DN20 x DN20 x DN15	1.050	1.050	2.01	1.89	1.57	1.04	0.5
	26.7	26.7	51.1	48.0	39.9	26.4	0.2
		1.050	2.01	1.89	1.56	1.02	0.6
		26.7	51.1	48.0	39.6	25.9	0.3
1 x 1 x 1/2 DN25 x DN25 x DN15	1.315	1.315	2.27	2.17	1.70	1.17	0.9
	33.4	33.4	57.7	55.1	43.2	29.7	0.4
		1.050	2.27	2.17	1.70	1.15	0.9
		26.7	57.7	55.1	43.2	29.2	0.4
		1.315	2.27	2.17	1.83	1.15	1.1
	33.4	57.7	55.1	46.5	29.2	0.5	
1 1/2 x 1 1/2 x 1/2 DN40 x DN40 x DN15	1.900	1.900	2.72	2.68	1.99	1.46	1.4
	48.3	48.3	69.1	68.1	50.5	37.1	0.6
		1.050	2.72	2.68	1.99	1.44	1.5
		26.7	69.1	68.1	50.5	36.6	0.7
		1.315	2.72	2.68	2.12	1.44	1.5
	33.4	69.1	68.1	53.8	36.6	0.7	
2 x 2 x 1/2 DN50 x DN50 x DN15	2.375	2.375	3.21	3.17	2.23	1.70	1.7
	60.3	60.3	85.1	80.5	56.6	43.2	0.8
		1.050	3.21	3.17	2.23	1.68	1.7
		26.7	85.1	80.5	56.6	42.7	0.8
		1.315	3.21	3.17	2.36	1.68	2.0
	33.4	85.1	80.5	59.9	42.7	0.9	

² Available with British Standard Pipe Threads. Specify BSPT on order.

4.3 DIMENSIONS

Elbows

Style P568 90° Elbow (P x P)

Style P562 90° Street Elbow (P x T)

Style P571 45° Elbow (P x P)

Style P563 45° Street Elbow (P x T)

Working Pressure: 500 psi/3447 kPa

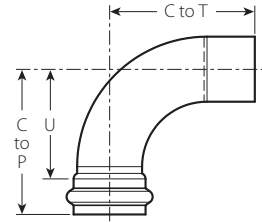
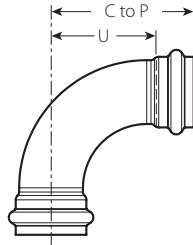

Size		Style P568 90° Elbow			Style P562 90° Street Elbow			
Nominal	Actual Outside Diameter	C to P	U Takeout	Approximate Weight (Each)	C to P	U Takeout	C to T	Approximate Weight (Each)
inches DN	inches mm	inches mm	inches mm	lb kg	inches mm	inches mm	inches mm	lb kg
½ DN15	0.840 21.3	2.64 67.1	1.53 38.9	0.3 0.1	2.64 67.1	1.53 38.9	3.04 77.2	0.3 0.1
¾ DN20	1.050 26.7	2.95 74.9	1.89 48.0	0.4 0.2	2.95 74.9	1.89 48.0	3.35 85.1	0.4 0.2
1 DN25	1.315 33.4	3.52 89.4	2.33 59.2	0.8 0.4	3.52 89.4	2.33 59.2	4.32 109.7	0.7 0.3
1 ½ DN40	1.900 48.3	4.55 115.6	3.18 80.8	1.4 0.6	4.55 115.6	3.18 80.8	4.55 115.6	1.4 0.6
2 DN50	2.375 60.3	5.52 140.2	3.90 99.1	2.0 0.9	5.52 140.2	3.90 99.1	5.52 140.2	2.0 0.9

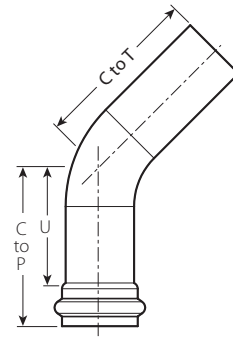
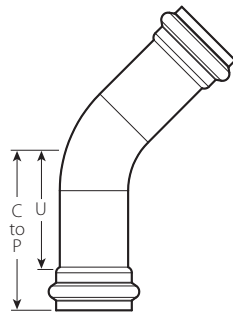

Size		Style P571 45° Elbow			Style P563 45° Street Elbow			
Nominal	Actual Outside Diameter	C to P	U Takeout	Approximate Weight (Each)	C to P	U Takeout	C to T	Approximate Weight (Each)
inches DN	inches mm	inches mm	inches mm	lb kg	inches mm	inches mm	inches mm	lb kg
½ DN15	0.840 21.3	1.89 48.0	0.83 21.1	0.2 0.1	1.89 48.0	0.83 21.1	1.89 48.0	0.2 0.1
¾ DN20	1.050 26.7	2.56 65.0	1.50 38.1	0.4 0.2	2.56 65.0	1.50 38.1	2.56 65.0	0.4 0.2
1 DN25	1.315 33.4	3.27 83.1	2.09 53.1	0.8 0.4	3.27 83.1	2.09 63.9	3.27 83.1	0.8 0.4
1 ½ DN40	1.900 48.3	4.96 126.0	3.59 91.2	1.7 0.8	4.96 126.0	3.59 91.2	4.96 126.0	1.7 0.8
2 DN50	2.375 60.3	5.84 148.3	4.22 107.2	2.5 1.1	5.84 148.3	4.22 107.2	5.84 148.3	2.5 1.1

4.4 DIMENSIONS

Male Threaded Adapter²

Style P576 (P x M)

Working Pressure: 500 psi/3447 kPa

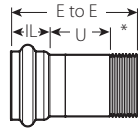

*Length of effective thread

Style P576

Size		Dimensions			Weight
Nominal inches DN	Actual Outside Diameter inches mm	E to E inches mm	U Takeout inches mm	IL Insertion Length inches mm	Approx. (Each) lb kg
1/2 x 1/2 DN15 x DN15	0.840 x 0.840 21.3 x 21.3	3.93 99.8	2.32 58.9	1.06 26.9	0.3 0.1
3/4 x 1/2 DN20 x DN15	1.050 x 0.840 26.7 x 21.3	3.34 84.8	1.75 44.5	1.06 26.9	0.4 0.2
		3.85 97.8	2.22 56.4	1.06 26.9	0.4 0.2
		1.315 33.4	3.34 84.8	1.60 40.6	1.06 26.9
1 x 3/4 DN25 x DN20	1.315 x 1.050 33.4 x 26.7	3.50 88.9	1.77 45.0	1.19 30.2	0.5 0.2
		4.19 106.4	2.32 58.9	1.19 30.2	0.6 0.3
		1.315 33.4	4.19 106.4	2.32 58.9	1.19 30.2
1 1/2 x 3/4 DN40 x DN20	1.900 x 1.050 48.3 x 26.7	3.65 92.7	1.73 43.9	1.38 35.1	0.8 0.4
		4.38 111.3	2.28 57.9	1.38 35.1	1.0 0.5
		2.375 60.3	2.375 60.3	2.46 62.5	1.63 41.4

² Available with British Standard Pipe Threads. Specify BSPT on order.

End Cap

Style P560

Working Pressure:
500 psi/3447 kPa

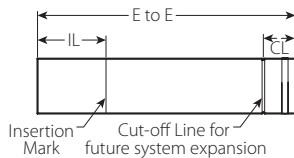

Style P560

Size		Dimensions			Weight
Nominal inches DN	Actual Outside Diameter inches mm	E to E inches mm	IL Insertion Length inches mm	CL Cut-off Line inches mm	Approx. (Each) lb kg
1/2 DN15	0.840 21.3	4.00 101.6	1.06 26.9	0.5 12.7	0.24 0.11
3/4 DN20	1.050 26.7	4.00 101.6	1.06 26.9	0.5 12.7	0.30 0.14
1 DN25	1.315 33.4	4.38 111.3	1.19 30.2	0.5 12.7	0.54 0.24
1 1/2 DN40	1.900 48.3	4.75 120.7	1.38 35.1	0.5 12.7	0.87 0.39
2 DN50	2.375 60.3	5.25 133.4	1.63 41.4	0.5 12.7	1.22 0.55

Female Threaded Adapter²

Style P579 (P x F)

Working Pressure: 500 psi/3447 kPa

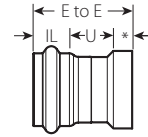

*Length of effective thread

Style P579

Size		Dimensions			Weight
Nominal inches DN	Actual Outside Diameter inches mm	E to E inches mm	U Takeout inches mm	IL Insertion Length inches mm	Approx. (Each) lb kg
1/2 x 1/2 DN15 x DN15	0.840 x 0.840 21.3 x 21.3	2.39 60.7	0.79 20.1	1.06 26.9	0.3 0.1
3/4 x 1/2 DN20 x DN15	1.050 x 0.840 26.7 x 21.3	2.31 58.7	0.71 18.0	1.06 26.9	0.3 0.1
		2.31 58.7	0.79 20.1	1.06 26.9	0.4 0.2
		1.315 33.4	3.34 84.8	1.60 40.6	1.06 26.9
1 x 1/2 DN25 x DN15	1.315 x 0.840 33.4 x 21.3	2.47 62.7	0.75 19.1	1.19 30.2	0.7 0.3
		2.47 62.7	0.73 18.5	1.19 30.2	0.6 0.3
		1.315 33.4	2.60 66.0	0.88 22.4	1.19 30.2
1 1/2 x 1 DN40 x DN25	1.900 x 1.315 48.3 x 33.4	2.92 74.2	0.91 23.1	1.38 35.1	1.0 0.5
		2.92 74.2	0.86 21.8	1.38 35.1	0.8 0.4
		1.900 48.3	2.92 74.2	0.86 21.8	1.38 35.1
2 x 1 1/4 DN50 x DN32	2.375 x 1.660 60.3 x 42.4	3.57 90.7	1.24 31.5	1.63 41.4	1.1 0.5
		3.57 90.7	1.24 31.5	1.63 41.4	1.3 0.6
		2.375 60.3	3.57 90.7	1.24 31.5	1.63 41.4

² Available with British Standard Pipe Threads. Specify BSPT on order.

4.5 DIMENSIONS

Threaded Union

Style P585 (P x P)

Working Pressure: 500 psi/3447 kPa

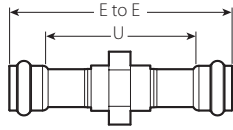

Style P585

Size		Dimensions		Weight
Nominal inches DN	Actual Outside Diameter inches mm	E to E inches mm	U Takeout inches mm	Approximate (Each) lb kg
1/2 DN15	0.840 21.3	7.50 190.5	5.37 136.4	3.0 1.4
3/4 DN20	1.050 26.7	7.37 187.2	5.24 133.1	3.7 1.7
1 DN25	1.315 33.4	7.59 192.8	5.21 132.3	4.3 2.0
1 1/2 DN40	1.900 48.3	8.36 212.3	5.61 142.5	6.0 2.7
2 DN50	2.375 60.3	8.01 203.5	4.76 120.9	6.8 3.1

Transition Nipple

Style P577 (G x T)

Working Pressure: 500 psi/3447 kPa

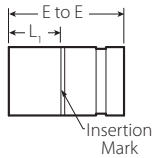

Style P577

Size		Dimensions		Weight
Nominal inches DN	Actual Outside Diameter inches mm	E to E inches mm	L1 Minimum inches mm	Approximate (Each) lb kg
3/4 DN20	1.050 26.7	4.00 101.6	1.06 26.9	0.3 0.1
1 DN25	1.315 33.4	4.00 101.6	1.19 30.2	0.5 0.2
1 1/2 DN40	1.900 48.3	4.00 101.6	1.38 35.1	0.7 0.3
2 DN50	2.375 60.3	4.00 101.6	1.63 41.4	0.9 0.4

Concentric Reducer

Style P574 (P x P)

Working Pressure: 500 psi/3447 kPa

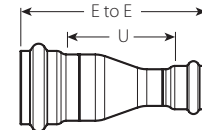

Style P574

Size		Dimensions		Weight	
Nominal inches DN	Actual Outside Diameter inches mm	E to E inches mm	U Takeout inches mm	Approximate (Each) lb kg	
3/4 DN20	1.050 26.7	4.25 108.0	2.13 54.1	0.5 0.2	
1 DN25	1.315 33.4	4.92 125.0	2.67 67.8	0.6 0.3	
1 1/2 DN40	1.900 48.3	5.57 141.5	3.13 79.5	0.9 0.4	
2 DN50	2.375 60.3	6.52 165.6	3.84 97.5	1.2 0.5	
1/2 DN15	0.840 21.3	4.84 122.9	2.59 65.8	0.7 0.3	
3/4 DN20	1.050 26.7	5.66 143.8	3.09 78.5	1.1 0.5	
1 DN25	1.315 33.4	6.60 167.6	3.79 96.3	1.4 0.6	
1 1/2 DN40	1.900 48.3	6.75 171.5	3.76 95.5	1.6 0.7	

4.6 DIMENSIONS

Flange Adapter

Raised face one-piece 316L stainless steel flange adapter

Style P575 (P x L)

Working Pressure: 275 psi/1896 kPa

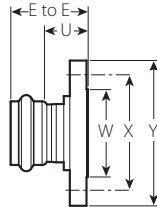

Style P575

ANSI Class 150 Flange Adapter							
Size		Dimensions					Weight
Nominal	Actual Outside Diameter	E to E	W	X	Y	U Takeout	Approx. (Each)
inches DN	inches mm	inches mm	inches mm	inches mm	inches mm	inches mm	lb kg
½	0.840	3.46	1.38	2.38	3.50	2.39	2.2
DN15	21.3	87.9	35.0	60.5	88.9	60.7	1.0
¾	1.050	3.34	1.69	2.75	3.88	2.27	2.3
DN20	26.7	84.8	42.9	69.9	98.6	57.7	1.0
1	1.315	3.46	2.00	3.12	4.25	2.27	2.8
DN25	33.4	87.9	50.8	79.3	108.0	57.7	1.3
1½	1.900	3.45	2.88	3.88	5.00	2.07	3.6
DN40	48.3	87.6	73.2	98.6	127.0	52.3	1.6
2	2.375	3.42	3.62	4.75	6.00	1.79	5.8
DN50	60.3	86.9	92.0	120.7	152.4	45.5	2.6

Van Stone Flange Adapter³

Carbon steel raised face slip on flange, with 316 stainless steel stub end

Style P566 (P x L)

Working Pressure: 275 psi/1896 kPa

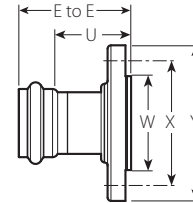

Style P565

Size		Dimensions					Weight
Nominal	Actual Outside Diameter	E to E	W	X	Y	U Takeout	Approx. (Each)
inches DN	inches mm	inches mm	inches mm	inches mm	inches mm	inches mm	lb kg
½	0.840	3.37	1.38	2.38	3.50	2.30	2.4
DN15	21.3	85.6	35.0	60.5	88.9	58.4	1.1
¾	1.050	3.29	1.69	2.75	3.88	2.22	2.5
DN20	26.7	83.6	42.9	69.9	98.6	56.4	1.1
1	1.315	3.45	2.00	3.12	4.25	2.26	3.0
DN25	33.4	87.6	50.8	79.3	108.0	57.4	1.4
1½	1.900	3.61	2.88	3.88	5.00	2.22	4.1
DN40	48.3	91.7	73.2	98.6	127.0	56.4	1.9
2	2.375	4.55	3.62	4.75	6.00	2.92	6.8
DN50	60.3	115.6	92.0	120.7	152.4	74.2	3.1

³ Not approved for use in maritime services.

AS 2129 Table E Flange Adapter							
Size		Dimensions					Weight
Nominal	Actual Outside Diameter	E to E	W	X	Y	U Takeout	Approx. (Each)
inches DN	inches mm	inches mm	inches mm	inches mm	inches mm	inches mm	lb kg
½	0.840	3.46	1.85	2.64	3.74	2.39	2.2
DN15	21.3	87.9	47.0	67.0	95.0	60.7	1.0
¾	1.050	3.34	2.89	2.87	3.94	2.27	2.3
DN20	26.7	84.8	53.0	73.0	100.0	57.7	1.0
1	1.315	3.46	2.48	3.37	4.53	2.27	2.8
DN25	33.4	87.9	63.0	83.0	115.0	57.7	1.3
1½	1.900	3.45	3.07	3.86	5.31	2.07	3.6
DN40	48.3	87.6	78.0	98.0	135.0	52.6	1.6
2	2.375	3.42	3.54	4.49	5.91	1.79	5.8
DN50	60.3	86.9	90.0	114.0	150.0	45.5	2.6

4.7 DIMENSIONS

Vic-Press™ Schedule 10S Type 316 Stainless Steel Ball Valve

Series P569³

Working Pressure: 400 psi/2758 kPa

- Series P569 Vic-Press™ for Schedule 10S System Ball Valves with Type 316 ends feature full stainless steel body and trim, rated for service up to 400 psi/2758 kPa.
- The valves are constructed of rugged Type 316 (CF8M) stainless steel with PTFE seats. The valves feature a blow-out proof stem and self-adjusting floating ball which provides uniform sealing. The full port design minimizes pressure drop for maximum flow efficiency. The three-piece swing-out design permits easy in-line maintenance.

Vic-Press™ for Schedule 10S x Vic-Press™ Schedule 10S (P x P)

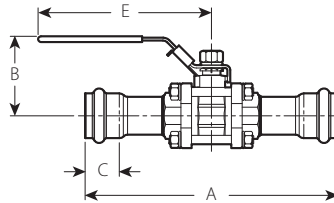

Size		Dimensions				Weight
Nominal	Actual Outside Diameter	A	B	C	E	Approximate (Each)
inches DN	inches mm	End to End inches mm	inches mm	inches mm	inches mm	lb kg
1/2 DN15	0.840 21.3	8.44 214.3	2.24 56.9	1.06 26.9	4.02 102.1	1.5 0.7
3/4 DN20	1.050 26.7	8.63 219.2	2.64 67.0	1.06 26.9	4.96 126.0	2.4 1.1
1 DN25	1.315 33.4	9.23 234.4	2.76 70.1	1.19 30.2	5.00 127.0	3.6 1.6
1 1/2 DN40	1.900 48.3	10.11 256.8	3.74 95.0	1.38 35.1	6.14 156.0	6.9 3.1
2 DN50	2.375 60.3	10.46 265.7	4.02 102.1	1.63 41.4	7.52 191.0	9.5 4.3

³ Not approved for use in maritime services

NOTE

- For dimensions and weights with gear operator contact Victaulic.

Groove x Groove (G x G)

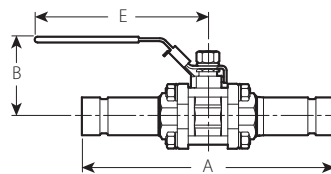

Size		Dimensions			Weight
Nominal	Actual Outside Diameter	A	B	E	Approximate (Each)
inches DN	inches mm	End to End inches mm	inches mm	inches mm	lb kg
3/4 DN20	1.050 26.7	8.81 223.8	2.64 67.0	4.96 126.0	2.4 1.1
1 DN25	1.315 33.4	9.21 234.0	2.76 70.1	5.00 127.0	3.6 1.6
1 1/2 DN40	1.900 48.3	11.25 285.8	3.74 95.0	6.14 156.0	6.9 3.1
2 DN50	2.375 60.3	12.74 323.6	4.02 102.1	7.52 191.0	9.5 4.3

³ Not approved for use in maritime services

NOTE

- For dimensions and weights with gear operator contact Victaulic.

4.7 DIMENSIONS (Continued)

Vic-Press™ Schedule 10S Type 316 Stainless Steel Ball Valve

Series P569³

Vic-Press™ Schedule 10S x Groove (P x G)

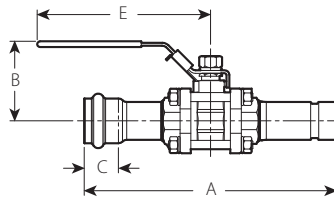

Size		Dimensions				Weight	
Nominal	Actual Outside Diameter	A End to End	B	C	E	Approximate (Each)	
inches DN	inches mm	inches mm	inches mm	inches mm	inches mm	lb kg	
¾ DN20	1.050 26.7	8.72 221.5	2.64 67.0	1.06 26.9	4.96 126.0	2.4 1.1	
1 DN25	1.315 33.4	9.21 234.0	2.76 70.1	1.19 30.2	5.00 127.0	3.6 1.6	
1½ DN40	1.900 48.3	10.68 271.3	3.74 95.0	1.38 35.1	6.14 156.0	6.9 3.1	
2 DN50	2.375 60.3	11.60 294.6	4.02 102.1	1.63 41.4	7.52 191.0	9.5 4.3	

³ Not approved for use in maritime services

NOTE

- For dimensions and weights with gear operator contact Victaulic.

Series P569

Body: Stainless steel, CF8M, ASTM A351

Ball: Stainless steel, CF8M, ASTM A351

Stem: Stainless steel, Type 316

Seats: (PTFE) Polytetrafluoroethylene

Locking Handle: Stainless steel, Type 304

Stem Nut: Stainless steel, Type 304

Stem Washer: Stainless steel, Type 304

Stem Packing and Thrust Washer: (PTFE) Polytetrafluoroethylene

Bolt/Nut/Washer: Stainless steel, Type 304

Cap: Stainless steel, CF8M, ASTM A351

Extended Ends: Schedule 10S stainless steel, Type 316

Specify end style:

- Vic-Press™ Schedule 10S x Vic-Press™ Schedule 10S (P x P)
- Grooved End (G x G)
- Vic-Press™ Schedule 10S x Grooved End (P x G)

5.0 PERFORMANCE

Flow Characteristics

- Flow testing for the Vic-Press™ Series P569 3-Piece Ball Valve demonstrated superior flow characteristics.
- Testing was performed in our own engineering laboratory facilities with systems and equipment calibrated to National Bureau of Standards.
- Cv/Kv values for flow of water at +60°F/+16°C with a fully open valve are shown in the table.

Formulas for Cv Values:

$$\Delta P = \frac{Q^2}{C_v^2}$$

$$Q = C_v \times \sqrt{\Delta P}$$

Where:

Q = Flow (GPM)
 ΔP = Pressure Drop (psi)
 Cv = Flow Coefficient

Formulas for Kv Values:

$$\Delta P = \frac{Q^2}{K_v^2}$$

$$Q = K_v \times \sqrt{\Delta P}$$

Where:

Q = Flow (m³/hr)
 ΔP = Pressure Drop (Bar)
 Kv = Flow Coefficient

Valve Size		Full Open
Nominal inches DN	Actual Outside Diameter inches mm	Flow Coefficient Cv Kv
½ DN15	0.840 21.3	10 90
¾ DN20	1.050 26.7	17 14
1 DN25	1.315 33.4	45 39
1 ½ DN40	1.900 48.3	125 107
2 DN50	2.375 60.3	365 314

Series P569 Repair Kits

- Kits and replacement parts are available for the Series P569 valve.
- The Repair Kit consists of one stainless steel ball, two seats, two gaskets, one stem seal and one thrust washer, all made of PTFE.
- For replacement stem information, contact Victaulic.

Size		Repair Kit
Nominal inches DN	Actual Outside Diameter inches mm	Part No.
½ DN15	0.840 21.3	K-004-569-0P2
¾ DN20	1.050 26.7	K-006-569-0P2
1 DN25	1.315 33.4	K-010-569-0P2
1 ½ DN40	1.900 48.3	K-014-569-0P2
2 DN50	2.375 60.3	K-020-569-0P2

5.1 PERFORMANCE

Vic-Press™ Brass Body Ball Valve with Stainless Steel Vic-Press™ Schedule 10S Ends

Series P589³ (P x P)

Working Pressure: 300 psi/2068 kPa

- Series P589 Ball Valve is a full port valve with Vic-Press™ Schedule 10S ends for fast, easy installation. The valve, with Vic-Press™ Schedule 10S ends, is designed for service to 300 psi/ 2068 kPa.
- The valve body is constructed from forged brass. The ball is chrome plated brass and seals on PTFE seats. A hollow ball design eliminates unnecessary weight while maintaining flow and mechanical strength. PTFE seats and washers reduce the friction coefficient which eases valve operation.

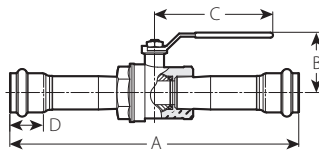

Size		Dimensions				Weight	Flow Coefficient ⁴ (Fully Open)
Nominal	Actual Outside Diameter	A ± 0.125 3.18	B	C	D	Approximate (Each)	Cv Values Kv Values
inches DN	inches mm	inches mm	inches mm	inches mm	inches mm	lb kg	
½ DN15	0.840 21.3	9.030 229.36	1.42 36.1	3.03 77.0	1.06 26.9	1.0 0.5	11 9.4
¾ DN20	1.050 26.7	9.12 231.65	1.90 48.3	3.74 95.0	1.06 26.9	1.6 0.7	25 21.3
1 DN25	1.315 33.4	10.10 256.74	2.05 52.1	3.74 95.0	1.19 30.2	2.8 1.3	36 30.7
1½ DN40	1.900 48.3	11.18 283.97	2.76 70.1	5.40 137.2	1.38 35.1	4.7 2.1	112 95.5
2 DN50	2.375 60.3	12.69 322.33	3.15 80.0	5.40 137.2	1.63 41.4	6.9 3.1	195 166.3

³ Not approved for use in maritime services.

⁴ Cv/Kv values for flow of water at +60°F/+16°C with valve fully open.

NOTES

- The Vic-Press™ Schedule 10S ends are of ASTM A312 Type 316 stainless steel.
- The Series P589 Brass Body Ball Valve is NOT ANSI/NSF certified for potable water. For potable water applications use the Series P569 Stainless Steel Ball Valve.

Series P589

Valve Body: Forged Brass ASTM B30

Ball: Brass ASTM B30, chrome plated

Stem: Brass ASTM B16

Seats: (PTFE) Polytetrafluoroethylene

Handle: Carbon steel, zinc plated

Stem Nut: Carbon steel, zinc plated

Stem Washer: (PTFE) Polytetrafluoroethylene

Extended Ends: Schedule 10S stainless steel, Type 316

5.2 PERFORMANCE

Pipe Support

- Piping joined with Vic-Press™ Schedule 10S products for Type 316 stainless steel requires support to carry the weight of pipes and equipment.
- The support or hanging method must be such as to eliminate undue stresses on joints, piping and other components. Additionally, the method of support must be such as to allow movement of the pipes where required and to provide drainage, etc., as may be specified by the designer.
- The maximum hanger spacing corresponds to ASME B31.1, B31.3 or B31.9 as noted and should be used in conjunction with Victaulic Vic-Press™ Schedule 10S System on Type 316 Schedule 10 stainless steel pipe.

Size		Suggested Max. Span Between Supports – Feet/meters					
Nominal inches DN	Actual Outside Diameter inches mm	Water Service			Gas/Air Service		
		B31.1	B31.3	B31.9	B31.1	B31.3	B31.9
½ DN15	0.840 21.3	6.5 2.0	6.5 2.0	7.0 2.1	7.0 2.1	7.0 2.1	7.5 2.3
¾ DN20	1.050 26.7	7.5 2.3	7.5 2.3	8.5 2.6	8.0 2.4	8.0 2.4	9.0 2.7
1 DN25	1.315 33.4	8.5 2.6	8.5 2.6	10.0 3.1	9.0 2.7	9.0 2.7	10.5 3.2
1½ DN40	1.900 48.3	10.0 3.1	10.0 3.1	12.5 3.8	11.0 3.6	11.0 3.6	13.5 4.1
2 DN50	2.375 60.3	11.0 3.6	11.0 3.6	13.0 4.0	12.5 3.8	12.5 3.8	15.5 4.7

5.3 PERFORMANCE

Thermal Expansion/Contraction

- For stainless steel pipes, expansion/contraction will occur with temperature changes at a rate of 1 1/8"/30mm per 100 feet of pipe per 100°F (96mm per 100 meters of pipe per 100°C). Piping which cannot expand or contract may create substantial stresses within the piping system resulting in damage to the piping system and/or components.
- The change in length due to thermal movement may be absorbed by the flexibility of the piping system, particularly in systems using light wall pipe. This can be done at a simple change in direction using an "L-Bend", or with an offset leg in a "Z-Bend" configuration or with a "U-Bend" (expansion loop).
- A proper design will utilize offset legs of sufficient minimum length prior to any element that will restrict movement (anchors, guides, fixed equipment connection) to minimize pipe stress. In addition, since these methods are symmetric about the offset axis, (i.e.: the expansion loop can open or close in equal amounts), the compensator needs to be sized for the greater of the thermal expansion or contraction from the installed ambient condition.

The following charts designate the minimum offset leg length for each of the aforementioned configurations were developed from the methodology found in ASHRAE Handbook – Systems and Equipment.

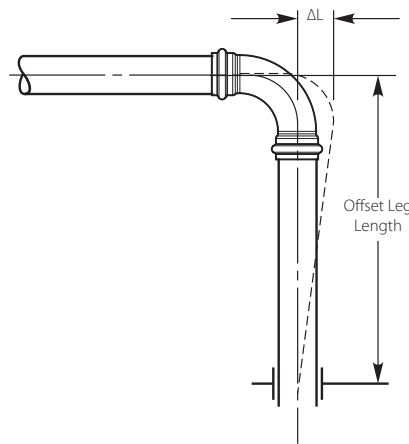

"L-Bend" Expansion Compensator
Figure 1

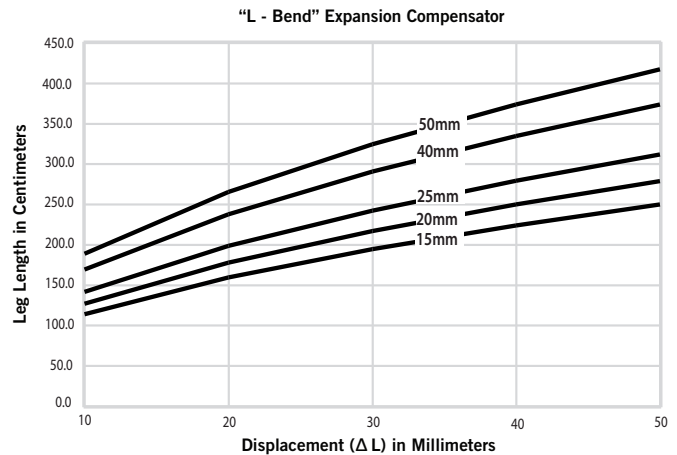
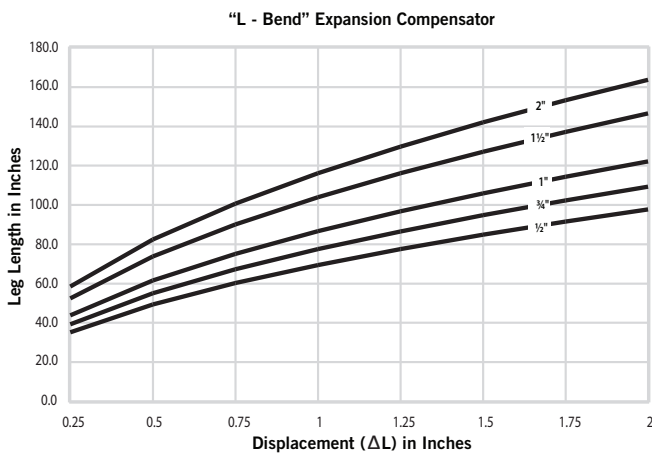

5.3 PERFORMANCE (Continued)

Thermal Expansion/Contraction

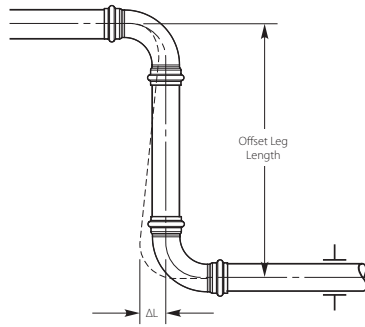

"Z-Bend" Expansion Compensator
Figure 2

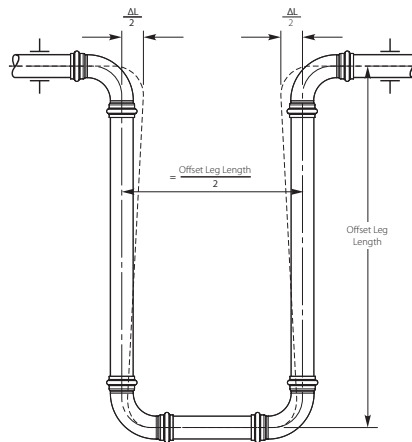
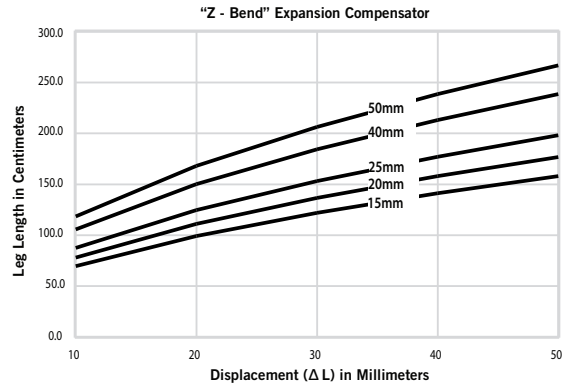
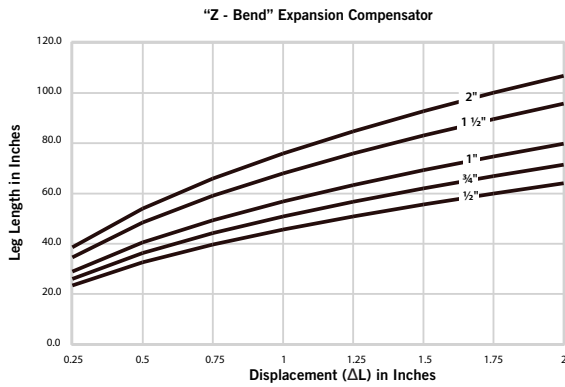

"U-Bend" Expansion Compensator
Figure 3

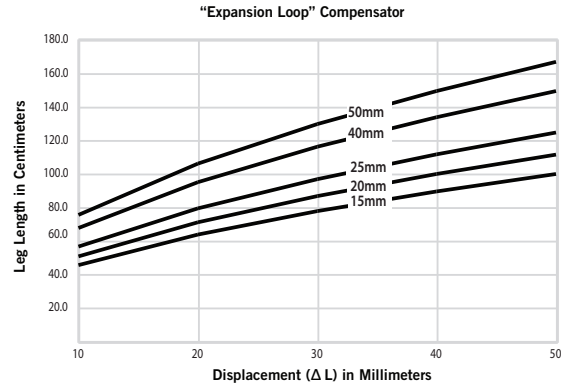
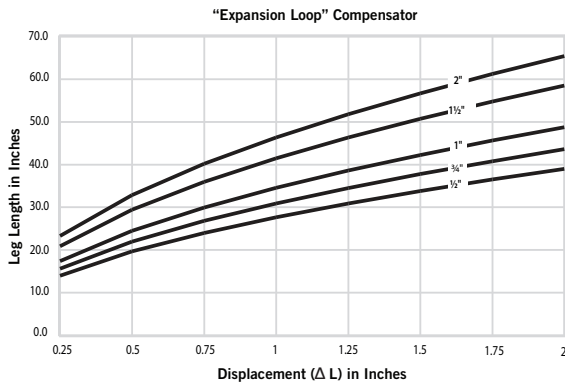

5.3 PERFORMANCE (Continued)

Thermal Expansion/Contraction

Examples

L-Bend

A 1"/25mm diameter pipeline will have thermal growth of 1.50"/40mm (ΔL) towards the elbow as shown in the above Figure 1. What is the minimum offset leg length from the elbow to the pipe restriction for the "L-Bend" configuration?

Use the "L-Bend" expansion compensator graph. Find the intersection of $\Delta L=1.50"/40mm$ (on the horizontal axis) where it crosses the 1"/25mm pipe curve. At that point, read the "Leg Length in Inches" (on the vertical axis) to determine the minimum offset leg length from the elbow to the pipe restriction. For a thermal growth of 1.50"/40mm of 1"/25mm diameter pipe in an "L-Bend" configuration, the minimum offset leg length should be 105"/2670mm.

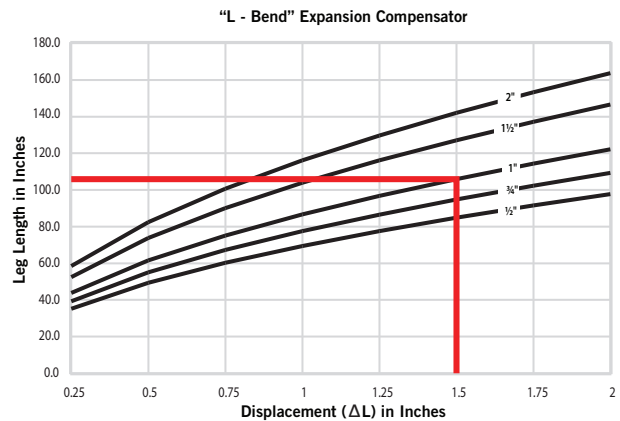

Z-Bend

A 1.50"/40mm diameter pipeline will have thermal growth of 1.25"/32mm between two opposing anchors, however, there is a perpendicular offset designed within the piping system that may be used to accommodate the thermal growth of the main run of pipe. What is the minimum offset leg length required for this "Z-Bend" configuration to accommodate the 1.25"/32mm of thermal growth?

Use the "Z-Bend" expansion compensator graph. Find the intersection of $\Delta L=1.25"/32mm$ (on the horizontal axis) where it crosses the 1.50"/40mm pipe curve. At that point, read the "Leg Length in Centimeter" (on the vertical axis) to determine the minimum offset leg length. For a thermal growth of 1.25"/32mm of 1.50"/40mm diameter pipe in a "Z-Bend" configuration, the minimum offset leg length should be 7.25"/186cm.

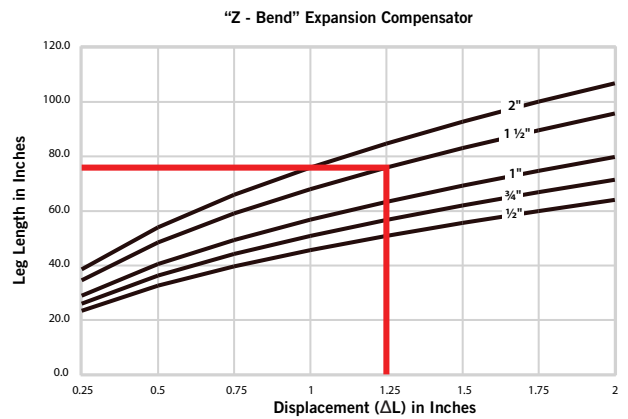

Expansion Loop

A 2"/50mm diameter pipeline will have thermal growth of 1.75"/45mm between two opposing anchors. The configuration of the system is such that there are no changes in direction; straight pipe only between the anchors. To accommodate the thermal growth an expansion loop will be required. What is the minimum offset leg length required for this expansion loop to accommodate the 1.75"/45mm of thermal growth?

Use the "Expansion Loop" compensator graph. Find the intersection of $\Delta L=1.75"/45mm$ (on the horizontal axis) where it crosses the 2"/50mm pipe curve. At that point, read the "Leg Length in Inches" (on the vertical axis) to determine the minimum offset leg length of the expansion loop. For a thermal growth of 1.75"/45mm of 2"/50mm diameter pipe in an "L-Bend" configuration, the minimum offset leg length should be 61"/1550mm.

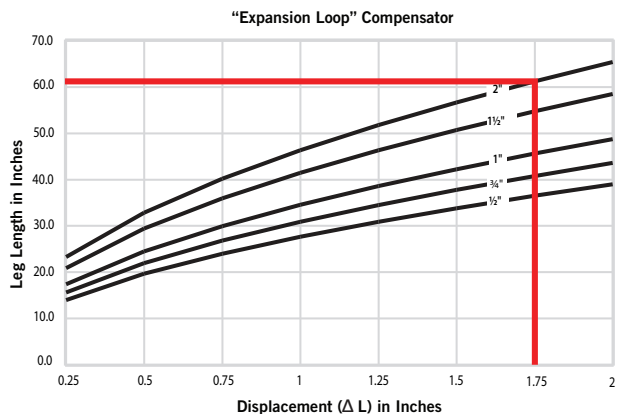

5.4 PERFORMANCE

Vic-Press™ PFT510 Tool



PFT510

- The Vic-Press™ PFT510 tool is specifically designed to join Vic-Press™ components to Schedule 10S⁵ stainless steel pipe. It can also be used for Schedule 5S pipe using Vic-Press™ components.
- Tool package includes one (1) Vic-Press™ PFT510 tool, two (2) 18V Lithium Ion batteries, one (1) battery charger, one (1) tool carrying case, one (1) jaw carrying case, one (1) ½"/15mm jaw, one (1) ¾"/20mm jaw, one (1) 1"/25mm jaw, one (1) 1½"/40mm hinged jaw, one (1) 2"/50mm hinged jaw, and one (1) adapter jaw, one (1) set of insertion gauges, one (1) cleaning brush, and one (1) marker.
- Jaws are included with every tool purchase.
- Vic-Press™ PFT510 is designed for industrial and trade use only

Capacity: ½"/DN15, ¾"/DN20, 1"/DN25, 1 ½"/DN40, 2"/DN50 Schedule 10S stainless steel pipe

Power Charger Requirements: 110 volt/60 cycle/6.5 amp

Optional: 220 volt

⁵ Can also be used for Schedule 5S pipe using Vic-Press™ components.

NOTE

- The Vic-Press™ for Schedule 10S System is not compatible with PFT505 and/or PFT509 tools/components. The Vic-Press™ Schedule 10S System requires the use of a Vic-Press™ FT510 tool package.

6.0 NOTIFICATIONS

WARNING

- Vic-Press™ for Schedule 10S products for Type 316/316L stainless steel must only be used on services compatible with seal and fitting materials.

Incompatible services may result in leakage. Always reference the latest [Victaulic Seal Selection Guide \(05.01\)](#) for specific seal service recommendations and for a listing of services which are not recommended.

WARNING

- It is the responsibility of designers of piping systems to verify the suitability of ASTM A312 Schedule 10S Types 316/316L stainless steel pipe for use with the intended fluid media. The fluid's chemical composition, pH level, operating temperature, chloride level, oxygen level and flow rate and their effect on ASTM A312 Types 316/316L stainless steel must be evaluated by the material specifier to confirm system life will be adequate for the intended service.

Failure to do so may cause serious personal injury or property damage.

7.0 REFERENCE MATERIALS

[02.06: Victaulic® Potable Water Approvals ANSI/NSF](#)

[05.01: Victaulic® Seal Selection Guide](#)

[18.12: Victaulic® Vic-Press™ for Schedule 10S Type 304 Stainless Steel](#)

[18.13: Victaulic® Vic-Press™ for Schedule 10S Qualification Test Data](#)

[18.14: Victaulic® 3 Piece Stainless Steel Ball Valve](#)

[18.16: Victaulic® Vic-Press™ for Schedule 10S ASME B31.1 Compliance](#)

[18.17: Victaulic® Vic-Press™ for Schedule 10S ASME B31.3 Compliance](#)

[18.18: Victaulic® Vic-Press™ for Schedule 10S ASME B31.9 Compliance](#)

[I-P500: Victaulic® Vic-Press™ Schedule 10S System Products](#)

[TM-PFT510: Operating and Maintenance Instruction Manual](#)

User Responsibility for Product Selection and Suitability

Each user bears final responsibility for making a determination as to the suitability of Victaulic products for a particular end-use application, in accordance with industry standards and project specifications, as well as Victaulic performance, maintenance, safety, and warning instructions. Nothing in this or any other document, nor any verbal recommendation, advice, or opinion from any Victaulic employee, shall be deemed to alter, vary, supersede, or waive any provision of Victaulic Company's standard conditions of sale, installation guide, or this disclaimer.

Intellectual Property Rights

No statement contained herein concerning a possible or suggested use of any material, product, service, or design is intended, or should be construed, to grant any license under any patent or other intellectual property right of Victaulic or any of its subsidiaries or affiliates covering such use or design, or as a recommendation for the use of such material, product, service, or design in the infringement of any patent or other intellectual property right. The terms "Patented" or "Patent Pending" refer to design or utility patents or patent applications for articles and/or methods of use in the United States and/or other countries.

Note

This product shall be manufactured by Victaulic or to Victaulic specifications. All products to be installed in accordance with current Victaulic installation/assembly instructions. Victaulic reserves the right to change product specifications, designs and standard equipment without notice and without incurring obligations.

Installation

Reference should always be made to the Victaulic installation handbook or installation instructions of the product you are installing. Handbooks are included with each shipment of Victaulic products, providing complete installation and assembly data, and are available in PDF format on our website at www.victaulic.com.

Warranty

Refer to the Warranty section of the current Price List or contact Victaulic for details.

Trademarks

Victaulic and all other Victaulic marks are the trademarks or registered trademarks of Victaulic Company, and/or its affiliated entities, in the U.S. and/or other countries.