

VE50T

PIPE ROLL GROOVING TOOL



WARNING

WARNING



Failure to follow instructions and warnings could result in serious personal injury, property damage, and/or product damage.

- Before operating or servicing any roll grooving tools, read all instructions in this manual and all warning labels on the tool.
- Wear safety glasses, hardhat, foot protection, and hearing protection while working around this tool.
- Save this operating and maintenance manual in a place accessible to all operators of the tool.

If you need additional copies of any literature, or if you have questions concerning the safe and proper operation of this tool, contact Victaulic, P.O. Box 31, Easton, PA 18044-0031, Phone: 1-800-PICK VIC, E-Mail: pickvic@victaulic.com.

Original Instructions

TABLE OF CONTENTS

Hazard Identification	4	Maintenance	28
Operator Safety Instructions	4	Lubrication	28
Introduction	6	Checking And Filling Gear Reducer Oil	30
Receiving The Tool	6	Checking And Filling Hydraulic Oil	30
Power Requirements	7	Replacing Hydraulic Oil And Filter	30
Tool Nomenclature	8	Air Bleeding	33
Tool Dimensions and Specifications	9	Recommended Lubricants	35
Tool Setup	10	Parts Ordering Information	35
Preparing Pipe For Grooving	13	Troubleshooting	36
Pipe Length Requirements	14	Explanation Of Critical Advanced Groove System Roll Groove Dimensions	38
Checking And Adjusting The Tool Prior to Grooving	15	Roll Groove Specifications	42
Adjusting The Roll Guards	15		
Pipe Stabilizer Adjustment	18		
Ram Speed Adjustment	20		
Dwell Control Adjustment	21		
Time Range Adjustment	21		
Pipe Size Adjustment	22		
Groove Diameter Stop Adjustment	22		
Grooving Operation	24		

HAZARD IDENTIFICATION

Definitions for identifying the various hazard levels are provided below.



This safety alert symbol indicates important safety messages. When you see this symbol, be alert to the possibility of personal injury.

Carefully read and fully understand the message that follows.



DANGER

- The use of the word “DANGER” identifies an immediate hazard with a likelihood of death or serious personal injury if instructions, including recommended precautions, are not followed.



WARNING

- The use of the word “WARNING” identifies the presence of hazards or unsafe practices that could result in death or serious personal injury if instructions, including recommended precautions, are not followed.



CAUTION

- The use of the word “CAUTION” identifies possible hazards or unsafe practices that could result in personal injury and product or property damage if instructions, including recommended precautions, are not followed.

NOTICE

- The use of the word “NOTICE” identifies special instructions that are important but not related to hazards.

OPERATOR SAFETY INSTRUCTIONS

The VE50T is designed for the sole purpose of roll grooving pipe. These instructions must be read and understood by each operator PRIOR to working with the grooving tools. These instructions describe safe operation of the tool, including set up and maintenance. Each operator must become familiar with the tool's operations, applications, and limitations. Particular care should be given to reading and understanding the dangers, warnings, and cautions described throughout these operating instructions.

Use of these tools requires dexterity and mechanical skills, as well as sound safety habits. Although these tools are designed and manufactured for safe, dependable operation, it is difficult to anticipate all combinations of circumstances that could result in an accident. The following instructions are recommended for safe operation of these tools. The operator is cautioned to always practice “safety first” during each phase of use, including set up and maintenance. It is the responsibility of the lessee or user of these tools to ensure that all operators read this manual and fully understand the operation of these tools.

Store this manual in a clean, dry area where it is always readily available. Additional copies of this manual are available upon request through Victaulic.



DANGER

1. **Avoid using the tool in potentially dangerous environments.** Do not expose the tool to rain, and do not use the tool in damp or wet locations. Do not use the tool on sloped or uneven surfaces. Keep the work area well lit. Allow sufficient space to operate the tool properly.
2. **Ground the tool to protect the operator from electric shock.** Tool components are grounded to the frame of the tool. Ensure that the frame is grounded properly prior to use.

3. **Disconnect electrical power before servicing the tool.** Only authorized personnel should perform maintenance on the tool. Always disconnect power before servicing or adjusting the tool.
4. **Prevent accidental startups.** Place the power switch in the “OFF” position before connecting the tool to an electrical source.

 **WARNING**

1. **Prevent back injury.** Do not attempt to lift tool components without the use of mechanical lifting equipment.
2. **Wear proper apparel.** Do not wear loose clothing, jewelry, or anything that can become entangled in moving parts.
3. **Wear protective items when working with tools.** Always wear safety glasses, hardhat, foot protection, and hearing protection.
4. **Keep hands and tools away from grooving rolls and stabilizer roller during the grooving operation.** Grooving rolls and stabilizer roller can crush or cut fingers and hands.
5. **Do not reach inside the pipe ends during tool operation.** Pipe edges can be sharp and can snag gloves, hands, and shirt sleeves. Fingers and hands can be crushed between the pipe and lower roll.
6. **Operate the tool only with a safety foot switch.** The power drive must be operated with a safety foot switch that is located for easy operator access. Never reach across moving parts. If the tool does not contain a safety foot switch, do not use the tool, and contact Victaulic.
7. **Do not over-reach.** Maintain proper footing and balance at all times. Ensure that the safety foot switch is easily accessible for the operator.

 **CAUTION**

1. **The VE50T tool is designed ONLY for roll grooving pipe sizes, materials, and wall thicknesses listed in the “Tool Rating and Roll Selection” section.**
2. **Inspect the equipment.** Before using the tool, check all moveable parts for any obstructions. Ensure that guards and tool components are installed and adjusted properly.
3. **Stay alert.** Do not operate the tool if you are drowsy from medication or fatigue.
4. **Keep visitors, trainees, and observers away from the immediate work area.** All visitors should be kept a safe distance from the equipment at all times.
5. **Keep work areas clean.** Keep the work area around the tool clear of any obstructions that could limit the movement of the operator. Clean up any oil or other spills.
6. **Secure the work, tool, and accessories.** Ensure that the tool is stable. Refer to the “Tool Setup” section.
7. **Support the work.** Support long pipe lengths with a pipe stand that is secured to the floor or the ground.
8. **Do not force the tool.** Do not force the tool or accessories to perform any functions beyond the capabilities described in these instructions. Do not overload the tool.
9. **Maintain tool with care.** Keep the tool clean at all times to ensure proper and safe performance. Follow the instructions for lubricating tool components.
10. **Use only Victaulic replacement parts and accessories.** Use of any other parts may result in a voided warranty, improper operation, or hazardous situations. Refer to the “Parts Ordering Information” and “Accessories” sections.
11. **Do not remove any labels from the tool.** Replace any damaged or worn labels.
12. **Always use handrails while ascending or descending the tool platforms.**

INTRODUCTION

NOTICE

- **Drawings and/or pictures in this manual may be exaggerated for clarity.**
- **The tool, along with this operating and maintenance instructions manual, contains trademarks, copyrights, and/or patented features that are the exclusive property of Victaulic Company.**

The VE50T Roll Grooving Tool is a fully motorized, semi-automatic, hydraulic-feed tool for roll grooving pipe to receive Victaulic grooved pipe products. The standard VE50T tool is supplied with one roll set as ordered for the intended job requirements, which is already installed on the tool. VE50T rolls are marked with the size and part number, and they are color coded to identify the pipe material. For roll grooving other specifications or materials, refer to the applicable “Tool Rating and Roll Selection” section. Grooving tools for other specifications, sizes, and materials must be purchased separately.



CAUTION

- **These tools must be used ONLY for roll grooving pipe designated in the applicable “Tool Rating and Roll Selection” section of this manual.**

Failure to follow this instruction could overload the tool, resulting in reduced tool life and/or damage to the tool.

RECEIVING THE TOOL

VE50T tools are palletized individually and enclosed in a wooden or cardboard sleeve that is designed for repeated shipping. Save the original container for return shipment of rental tools.

Upon receipt of the tool, ensure that all necessary parts are included. If any parts are missing, contact Victaulic.

VE50T CONTAINER CONTENTS

Qty.	Description
1	VE50T Pipe Roll Grooving Tool
1	Stabilizer Assembly (Pre-Installed)
2	Safety Foot Switch with Detachable Line Cord
1	Roll Set
1	Pipe Tape
1	Bleeder Tube
1	Guard Pad
2	Operating and Maintenance Instructions Manual

POWER REQUIREMENTS

 **DANGER**



- **Only a qualified electrician should connect incoming power to the tool.**
- **To reduce the risk of electric shock, check the electrical source for proper grounding.**
- **Always turn off the main power supply to the tool before making any tool adjustments or before performing any maintenance.**

Failure to follow these instructions could result in death or serious personal injury.

The VE50T is designed to operate on a 480-volt, 3-phase, 60-Hz power supply. This tool features a Variable Frequency Drive, which compensates for any potential deviation in power supply frequency.

NOTE: The Variable Frequency Drive is pre-set and locked during assembly of this tool.

 **WARNING**

- **Tampering with the Variable Frequency Drive is prohibited.**

Failure to follow these instructions could result in serious personal injury or death and property damage.

POWER HOOKUP AND VERIFICATION OF PIPE ROTATION DIRECTION

The VE50T requires a 1½-inch No. 8 conduit for electrical hookup. The tool is equipped with a “**TEST (JOG)**” setting. Operating the tool in the “**TEST (JOG)**” setting allows for:

- Determining rotation of the tool’s lower roll
- Confirming that the pipe to be grooved is tracking properly on the lower roll

1. Place the selector switch on the control panel to the “**TEST (JOG)**” mode and momentarily depress the “**HYDRAULIC PUMP START**” button to energize the lower roll. Observe lower roll rotational direction. Release the “**HYDRAULIC PUMP START**” button to de-energize the lower roll. **NOTE:** The safety foot switch does not need to be depressed while the tool is in the “**TEST (JOG)**” mode.

2. Proper rotation of the lower roll is **CLOCKWISE** when viewed from the front of the tool. If rotation is clockwise, power hookup is complete. If rotation is counterclockwise, contact Victaulic.

NOTE: Verify lower roll rotation prior to completing the Sealtite connection and re-installing the rear electrical connection access sheet metal panel.

TOOL NOMENCLATURE

NOTICE

- Drawings and/or pictures in this manual may be exaggerated for clarity.
- The tool, along with this operating and maintenance instructions manual, contains trademarks, copyrights, and/or patented features that are the exclusive property of Victaulic.

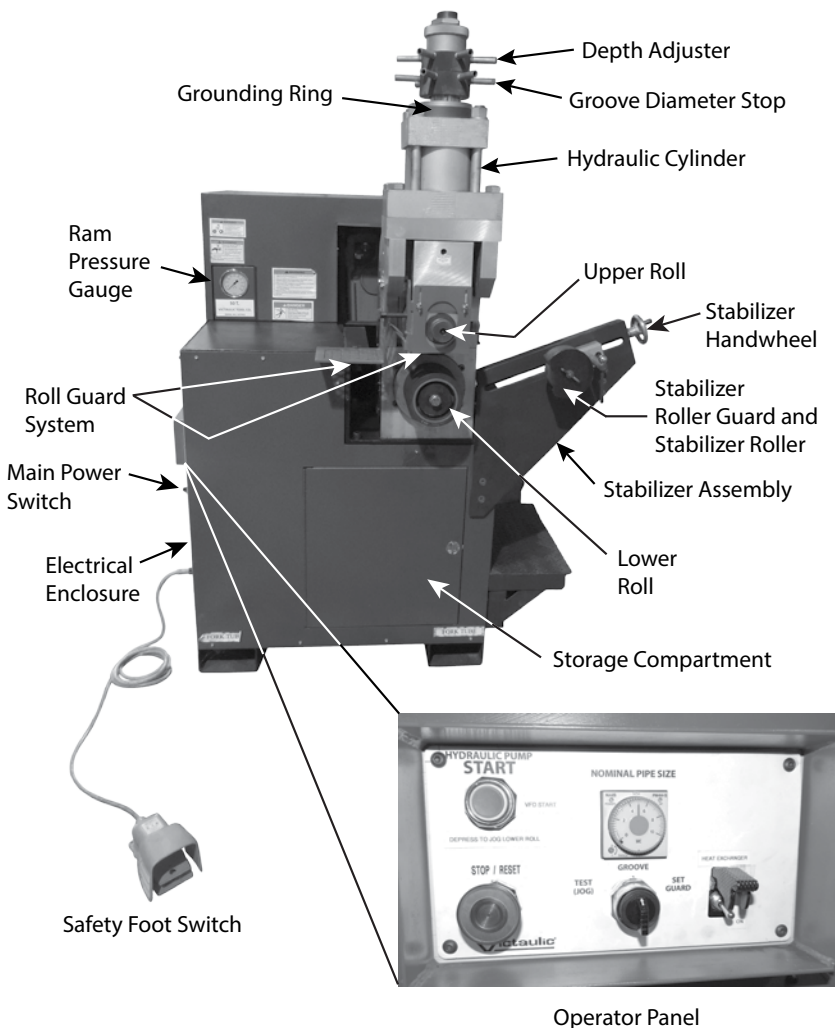

TOOL DIMENSIONS AND SPECIFICATIONS

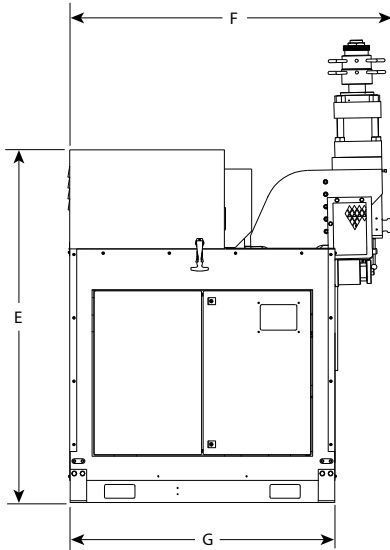
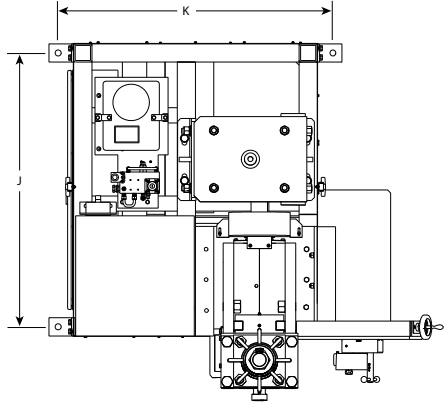
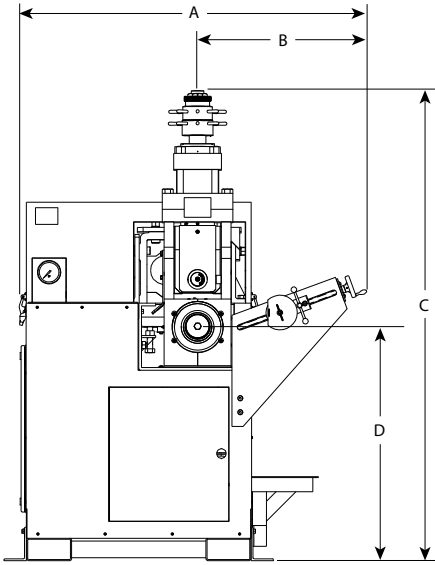

Dimensions – inches/millimeters									Tool Weight lbs/kg
A	B	C	D	E	F	G	J	K	
61.68	30.18	83.91	41.86	64.00	58.68	48.00	45.00	45.12	3800
1566.7	766.6	2131.3	1063.2	1625.6	1490.5	1219.2	1143.0	1146.1	1725

TOOL SETUP

A forklift is the only approved method of lifting and moving the VE50T tool. Forklift points have been noted on the tool.

WARNING

- **The tool or bottom support base MUST always be anchored to a sturdy, level concrete floor that is capable of handling the weight of the tool and accessories.**
- **Handrails must be installed and the electrical cord/safety foot switch cord must be routed through the support base to prevent tripping hazards.**
- **A forklift is the only approved method of lifting or moving the VE50T tool. The use of an overhead crane, ropes, chains, or slings is prohibited.**
- **DO NOT turn on the main power supply to the tool until instructed otherwise.**

Failure to follow these instructions could result in serious personal injury and property damage.

A support base is required when using a VE50T Roll Grooving Tool to groove pipe larger than 24 inches/600 mm. Larger sizes may require multiple bases. These bases are purchased separately from the VE50T tool.

Each support base is 16.50 inches/419.1 mm high and weighs 250 lbs. The support base assembly includes all needed hardware, including the 1-12 x 2 1/4-inch tool attachment bolts and 3/4 x 4 3/4-inch RED HEAD® anchor bolts.

When grooving pipe 24 inches or smaller, anchor the VE50T tool directly to the floor using the steps that follow.

1. Remove all components from the packaging, and ensure that all necessary items are included. Refer to the “Receiving the Tool” section.
2. The VE50T Roll Grooving Tool with support base is designed for use in a permanent location and must be located on a sturdy, level concrete floor. After an appropriate location is chosen, the bottom support base must be leveled and securely anchored. A non-level tool can severely affect grooving operation.
3. Select a location for the tool/support base and pipe stand by taking into consideration the following factors:
 - a. The required power supply (refer to the “Power Requirements” section)
 - b. Ambient temperature requirements of 20° F to 104° F/-21° C to 26° C
 - c. A level concrete floor for the tool/support base and pipe stand
 - d. Adequate space to handle pipe lengths
 - e. Adequate clearance around the tool/support base for adjustment and maintenance (4 feet/1.2 m on all sides)

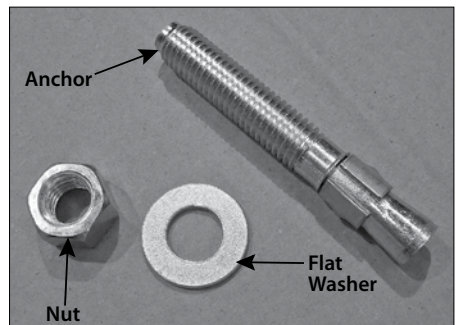

4. Wedge-type concrete floor anchors (3/4 x 4 1/4-inch size) must be used to secure the bottom platform to the floor. Ensure that the floor anchors are installed into the concrete floor in accordance with the manufacturer's instructions.

®RED HEAD is a registered trademark of Illinois Tool Works, Inc.



5. Using a forklift, raise the VE50T over the area where the floor anchors are installed. **NOTE:** The forks must be engaged with each “FORK TUBE”. Align the four holes in the support base with the four floor anchors. Slowly lower the VE50T over the floor anchors.



6. Install a flat washer and nut onto each of the floor anchors, as shown above. Tighten the nut completely.

7. As the tool is being lowered onto the support base, ensure that the power cord is guided out of the way and that the safety foot switch cord is disconnected to prevent damage. The holes in the base of the tool must align with the innermost holes in the support base.

8. Locate the bolt, two flat washers, lock washer, and nut (supplied with the support base kit). This hardware is required to anchor the tool and support base to each other.

9. Insert a bolt with a flat washer up through the hole in the support base and into the hole in the base of the tool. Apply a flat washer, lock washer, and nut to the end of the bolt. Tighten the nut completely until the lock washer is compressed. Repeat this step for the other three hole locations in the support base and tool base.

NOTICE

- VE50T tools are equipped with a detachable safety foot switch cord. The safety foot switch can be removed easily for storage in the cabinet when the tool is not in use.

⚠ WARNING

- Handrails must be installed and the electrical cord/safety foot switch cord must be routed through the support base to prevent tripping hazards.

Failure to follow these instructions could result in serious personal injury.



10. Route the safety foot switch cord up through the support base. Plug the safety foot switch cord into the receptacle on the side of the tool by aligning the pins/tab of the male adapter plug with the receptacle. Tighten the locking ring on the plug.

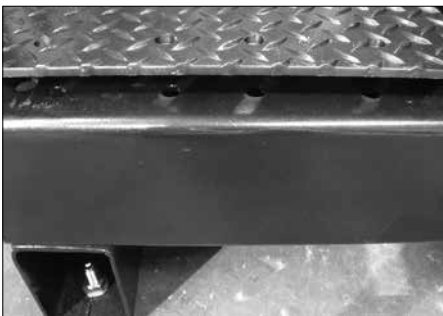

11. Install the platform onto the support base. Align the holes in the platform with the holes in the support base, as shown above. Repeat this step for the other side of the tool.

12. Locate the hex-head bolt, lock washer, and hex nut (supplied with the support base kit). This hardware is required for installation of the handrail bases.

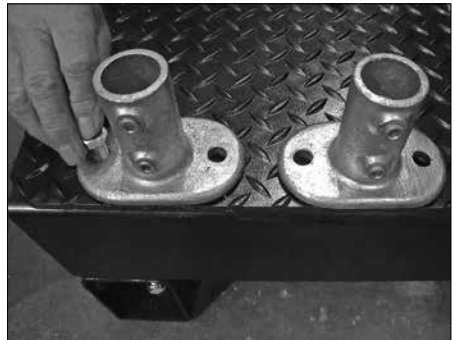

13a. Install a handrail base onto the platform at the eight locations on the platform/tool support. Ensure that the holes in the handrail bases align with the holes in the platforms/support base and that the set screws on the handrail bases face away from the platform, as shown above.

13b. Install a hex-head bolt through the two holes in each handrail base and into the platform/tool support. Apply a lock washer and hex nut onto the end of each hex-head bolt.



13c. Tighten the hex nut completely until the lock washer is compressed. Repeat this step for each handrail base location.

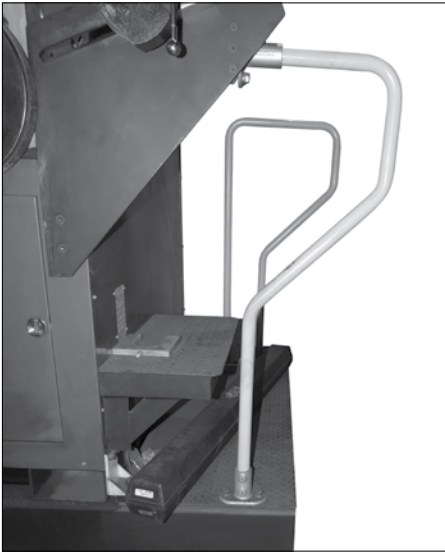

13d. Insert a handrail into each handrail base.
NOTE: The modified handrail must be installed at the stabilizer, as shown above.

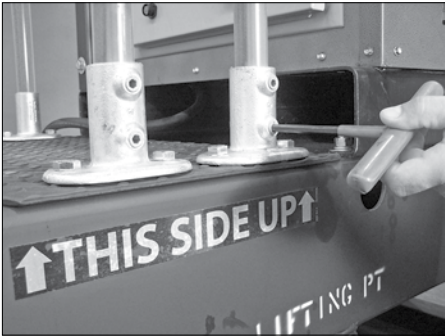

13e. Tighten the two set screws on each handrail base to retain the handrails.
Installation of the support base is now complete.

PREPARING PIPE FOR GROOVING

For proper tool operation and production of grooves that are within Victaulic specifications, the following pipe preparation steps must be followed.

Victaulic recommends square-cut pipe for use with grooved-end pipe products. Square-cut pipe **MUST** be used with Victaulic FlushSeal® and EndSeal® gaskets.

1. For all pipe sizes, raised internal and external weld beads and seams must be ground flush with the pipe surface 4½ inches/115 mm back from the pipe ends.
2. All coarse scale, dirt, and other foreign material must be removed from the interior and exterior surfaces of the pipe ends.

CAUTION

- For maximum grooving roll life, remove foreign material and loose rust from the interior and exterior surfaces of the pipe ends. Rust is an abrasive material that will wear the surface of grooving rolls.

Foreign material may interfere with or damage grooving rolls, resulting in distorted grooves and/or grooves that are out of Victaulic specifications.

PIPE LENGTH REQUIREMENTS

NOTICE	
<ul style="list-style-type: none"> Always use a pipe stand when roll grooving pipe. DO NOT roll groove pipe lengths shorter than 18 inches/460 mm. 	

TABLE 1 PIPE LENGTHS SUITABLE FOR GROOVING

Pipe Size		Length – inches/mm		Pipe Size		Length – inches/mm	
Nominal Pipe Size inches or mm	Actual Pipe Outside Diameter inches/mm	Minimum	Maximum	Nominal Pipe Size inches or mm	Actual Pipe Outside Diameter inches/mm	Minimum	Maximum
377 mm	14.843 377	12 305	16 410	32 OD	32.000 813		
15 OD	15.000 381	12 305	16 410	36 OD	36.000 914		
16 OD	16.000 406.4	12 305	16 410	38 OD	38.000 965		
426 mm	16.772 426	12 305	16 410	40 OD	40.000 1016		
18 OD	18.000 457	NOTE: Always use a pipe stand when roll grooving pipe. DO NOT roll groove pipe lengths shorter than 18 inches/ 460 mm in these sizes.		42 OD	42.000 1067		
480 mm	18.898 480			44 OD	44.000 1118		
20 OD	20.000 508			46 OD	46.000 1168		
530 mm	20.866 530			48 OD	48.000 1219		
22 OD	22.000 559			52 OD	52.000 1321		
24 OD	24.000 610			54 OD	54.000 1372		
650 mm	25.591 650			56 OD	56.000 1422		
26 OD	26.000 660			60 OD	60.000 1524		
28 OD	28.000 711			72 OD	72.000 1829		

CHECKING AND ADJUSTING THE TOOL PRIOR TO GROOVING

Every Victaulic roll grooving tool is checked, adjusted, and tested at the factory prior to shipment. However, before attempting to operate the tool, the following checks and adjustments should be made to ensure proper tool operation.

WARNING

- Always turn off the main power supply to the tool before making any tool adjustments.

Failure to follow this instruction could result in serious personal injury.

ADJUSTING THE ROLL GUARDS

The VE50T tool features a “**SET GUARD**” control switch setting. With the correct pipe size and schedule inserted in the tool, the “**SET GUARD**” setting allows the operator to complete the necessary guard adjustments.



1. Retract the depth adjusters to allow for full travel of the hydraulic cylinder.

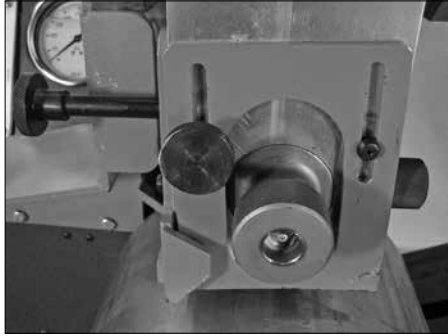

- 2a. Loosen the knob on the front of the roll guards to raise the plate to its highest position. Tighten the knob.

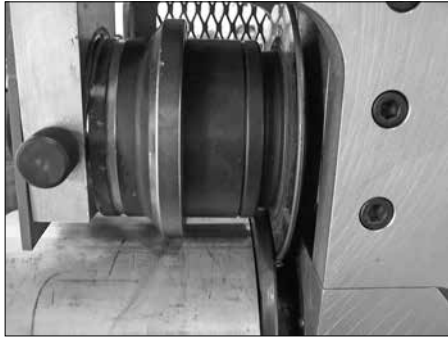

- 2b. Insert a length of pipe that is the correct size and schedule over the lower roll. Ensure that the pipe end contacts the lower-roll backstop flange. The pipe must rest directly on top of the roll and must not be skewed to one side or the other.



3. Place the selector switch on the control panel to the **"SET GUARD"** mode. Depress the safety foot switch to place the tool's hydraulic system under pressure. Movement of the tool's ram/slide/upper roll will occur. The hydraulic pump will shut off automatically when the upper roll contacts the pipe and an increase in hydraulic system pressure occurs. Release the safety foot switch. The ram assembly will remain down. If hydraulic pressure is not established, the ram will return to the neutral position as the safety foot switch is released.



4. Prior to making tool guard adjustments, push down (in) on the emergency **"STOP"** knob on the control panel. The upper roll will continue to remain seated against the pipe.

NOTE: Heat exchanger should remain in the **"ON"** position in normal operation.

WARNING

- The roll guards must be spaced properly by using the appropriate guard setting pad.

Failure to follow this instruction could result in serious personal injury.



5. Hold the guard setting pad firmly against the pipe and push it under the roll guards. Loosen the knob on the front of the roll guards to drop the plate onto the guard setting pad. Tighten the knob.

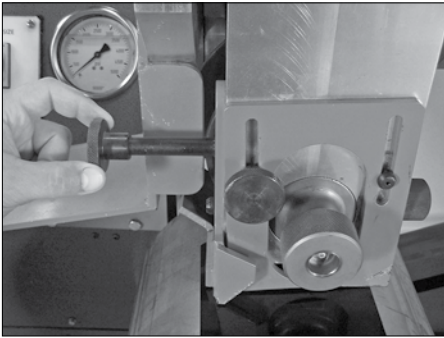

6. Loosen the knob on the left side of the roll guard to drop the side sliding guard onto the guard setting pad. Tighten the knob.

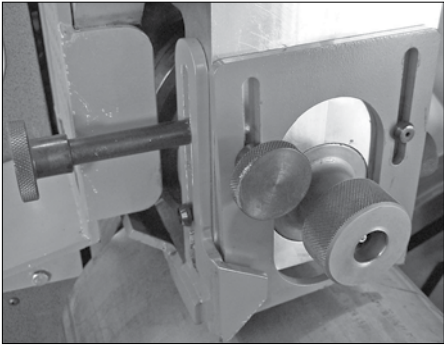

7. Remove the guard setting pad from the pipe. Store the guard setting pad in a safe location.



8. When tool guard adjustments are complete, pull the emergency “STOP” knob on the control panel to the out position.



9. Depress and release the “HYDRAULIC PUMP START” button. The tool’s hydraulic pump motor will energize and the tool’s ram shaft will retract to the neutral position.

10. The guard setting procedure is complete.

PIPE STABILIZER ADJUSTMENT

WARNING

- Always turn off the main power supply to the tool before making any tool adjustments.
- DO NOT reach over pipe while making adjustments.
- DO NOT make adjustments while the tool/pipe is in operation/motion.

Failure to follow these instructions could result in serious personal injury.

The pipe stabilizer for the VE50T is designed to prevent pipe sway. When the stabilizer is adjusted for a selected pipe size and wall thickness, it does not require further adjustment unless pipe of a different size or wall thickness will be grooved. Pipe of the same size and wall thickness can be moved in and out of the tool without retracting the stabilizer.



1. Loosen the stabilizer locking handle.

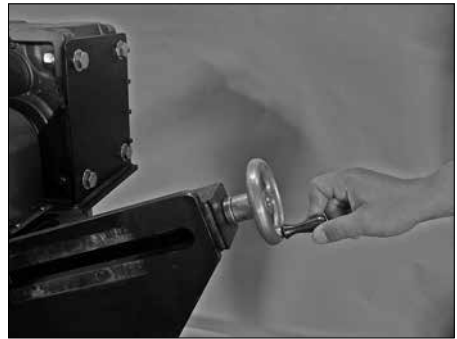

2. Using the stabilizer handwheel, retract the stabilizer roller to clear the pipe when it is inserted onto the lower roll.

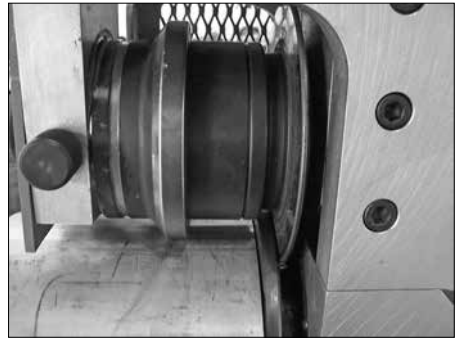

3. Insert a length of pipe that is the correct size and schedule over the lower roll. Ensure that the pipe end contacts the lower-roll backstop flange. The pipe must rest directly on top of the roll and must not be skewed to one side or the other.
4. Follow steps 3 and 4 on page 16 to rest the upper roll on the pipe outer diameter.

CAUTION

- **DO NOT** adjust the stabilizer roller to push the pipe to the left and off center from the rolls. Increased pipe-end flare and shortened roll life will result if the pipe is pushed to the left and off center.
- **DO NOT** reach across the pipe to make pipe stabilizer adjustments.
- **DO NOT** adjust the pipe stabilizer while the pipe is in motion.
- **Assembly of couplings on pipe that exceeds the maximum allowable flare dimension may prevent proper pad-to-pad assembly of coupling housings and gasket distortion/damage.**

Failure to prepare pipe in accordance with all instructions may cause joint failure, resulting in personal injury and/or property damage.



5. Using the stabilizer handwheel, adjust the stabilizer roller toward the pipe.

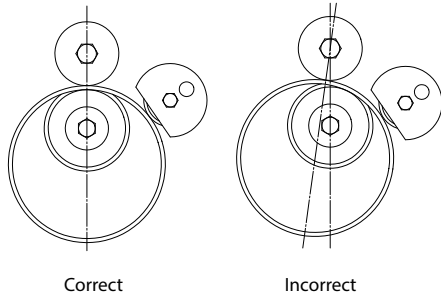

NOTE: DO NOT adjust the stabilizer roller too far inward. Doing so will skew the pipe to the left and off center, resulting in excessive pipe-end flare. Refer to the drawing above for proper positioning.



6. Loosen the roller guard's set knob to position the roller guard so that the opening faces the pipe directly. Ensure that the guard does not rub the pipe. Tighten the roller guard's set knob.



7. Tighten the stabilizer locking handle.
8. Complete all adjustments and groove the pipe. Refer to the "Grooving Operation" section. Observe the stabilizer roller while grooving. It should remain in contact with the pipe, and the pipe should rotate smoothly without swaying from side to side. If the pipe is not rotating smoothly or is swaying from side to side, discontinue grooving and adjust the stabilizer roller. Continue the grooving operation and make further adjustments, as necessary.

RAM SPEED ADJUSTMENT

1. Locate the key, which is inserted into the ram speed control valve at the factory.



2. Turn the key to unlock the ram speed control valve.
3. With the key inserted into the ram speed control valve, rotate the knob until it "locks in."

4. Determine the desired ram speed as follows:
 - a. Calculate the approximate pipe OD in imperial units and divide this number by 2.
 - b. The result from "a." will equal the number of seconds it should take for the ram to reach maximum pressure.

Example:

$$\frac{36 \text{ in}}{2} = 18$$

The target time is 18 seconds.

5. Determine the current ram speed as follows:
 - a. Move the depth stop to an arbitrary position (the closer to the grounding ring, the better).
 - b. Disconnect the wire (shown in the image below) from the grounding plate on top of the cylinder.

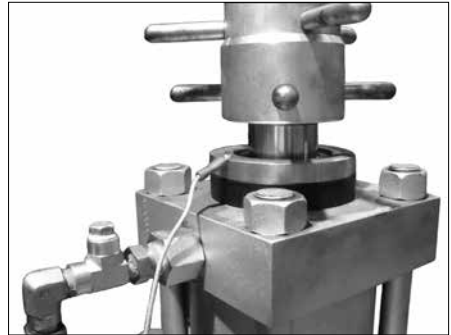

- c. Depress the foot pedal to move the ram down. Pay attention to the pressure gauge.
 - c. As soon as the ram bottoms out on the grounding ring, the pressure will immediately start to rise. Count the number of seconds it takes for the pressure to change from zero to 3000 psi. This number should equal the number calculated in step 4.
 - d. If these numbers do not match, turn the flow control valve until desired results are achieved.
 - e. The initial ram speed control valve setting should be 4.0 for carbon steel pipe, with adjustments being made as needed. 10.0 is the maximum speed setting.

6. After the ram speed is set, unlock the ram speed control valve and remove the key. Store the key in a safe location on the tool.

7. Reconnect the grounding wire at the top of the cylinder.

NOTE: The electrical panel and heat exchanger valve lock-out keys are attached to the ram speed control valve key. Store all of these keys in a safe location.

NOTICE

- The ram speed affects only the rate at which the upper roll forms the groove. It does not affect the rate at which the upper roll advances to contact the pipe, nor does it affect the rate at which the roll retracts from the pipe at the completion of a groove.
- Ram speed during the formation of a groove can have a significant effect on pipe flare. The settings given in the previous steps will produce excellent grooves in most situations. However, if excessive flare results at these settings, reduce the setting to correct the condition. For example, adjust the ram-speed control valve to 3.0 or 3.5 for carbon steel pipe when flare is excessive at the 4.0 setting.

DWELL CONTROL ADJUSTMENT

The dwell control adjustment controls the length of time the tool continues to rotate the pipe after the groove diameter stop contacts the top of the hydraulic cylinder. The dwell control timer is adjustable for time range settings.

The pipe should rotate a minimum of one revolution after the groove diameter stop contacts the hydraulic cylinder. This ensures that the groove is of uniform depth around the entire pipe circumference.

TIME RANGE ADJUSTMENT

The time range setting will set the operating parameters of the timer. VE50T tools are factory set to 10.



1. Verify that the timer is set to 10 for initial test grooving.

CAUTION

- The timing range must be set to 10 before grooving begins.

Failure to follow this instruction could cause excessive or insufficient dwell, resulting in improper groove diameters and/or grooves that are not uniform in depth.

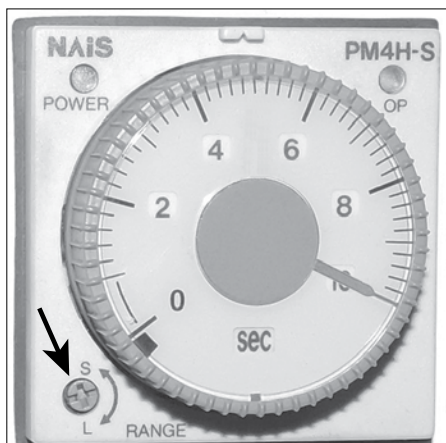

GROOVE DIAMETER STOP ADJUSTMENT

The groove diameter stop must be set for the appropriate pipe size. The groove diameter, which is identified as the “C” dimension, is listed under the “Roll Groove Specifications” section. In addition, a label affixed to the tool lists the “C” dimensions.

NOTICE

- To perform the following test, Victaulic recommends the use of several short, scrap sections of pipe that are the proper material, diameter, and thickness to be grooved. Ensure that the scrap sections meet the length requirements listed in Table 1.

2. If necessary, rotate the time range screw, located in the lower left-hand corner of the timer, to the desired range shown on the dial face.

CAUTION

- Use only a #0 Phillips-head screwdriver to adjust the range screw.

Failure to follow this instruction may damage the screw head.

3. If this setting does not produce grooves within Victaulic specifications, adjust the time accordingly.

PIPE SIZE ADJUSTMENT

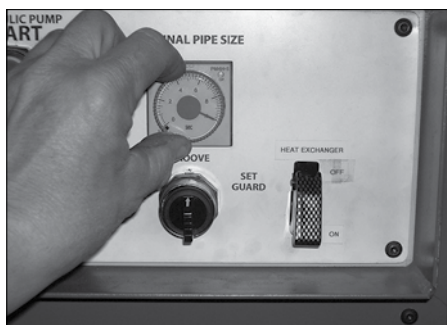

Ensure that the timer range provides at least one full pipe revolution of dwell time.

To check the groove diameter stop:

1. Energize the tool and set the control panel selector switch to the “SET GUARD” mode.
2. Load pipe onto the VE50T’s lower roll.
3. Depress the safety foot switch until the upper roll contacts the pipe.
4. When the hydraulic system pressure is realized, the “E-STOP” button can be depressed and the tool’s upper roll will be locked in place.

5. A key is tethered to the VE50T tool's hydraulic cylinder. Locate this key on the top surface of the tool's grounding ring and rotate the groove diameter stop barrel until this barrel's bottom surface contacts the key.



6. Remove the key from contacting the tool's grounding ring.

7. Prepare a trial groove. Refer to the "Grooving Operation" section.

NOTICE

- **Occasionally during grooving, the groove diameter stop may move up and down slightly, making and then breaking contact with the hydraulic cylinder. This is normal for pipe that has a noticeable weld seam or hard spot.**

CAUTION

- **Victaulic must be consulted regarding groove dimensions to ensure proper joint performance.**

Failure to follow this instruction could cause joint failure, resulting in personal injury and/or property damage.

8. After a trial groove is prepared and the pipe is removed from the tool, check the groove diameter ("C" dimension) carefully. A standard pipe tape, supplied with the tool, is the best method for checking the "C" dimension.

9. If the groove diameter ("C" dimension) is not within Victaulic specifications, the diameter stop must be adjusted.

GROOVING OPERATION

⚠ **DANGER**



- To reduce the risk of electric shock, check the tool for proper grounding and follow all instructions.
- Before operating the tool, review the “Operator Safety Instructions” section of this manual.

Failure to follow these instructions could result in death or serious personal injury.

⚠ **CAUTION**

- For long pipe lengths, ensure that the pipe stand is positioned properly to minimize pipe-end flare.
- DO NOT** install couplings on pipe that exceeds the maximum allowable flare.
- This tool must be used **ONLY** for roll grooving pipe designated in the applicable “Tool Rating and Roll Selection” section of this manual.
- Always refer to the applicable “Roll Groove Specifications” table for details.

Failure to follow these instructions could cause product failure, resulting in property damage.

When roll grooving pipe that exceeds the maximum length shown in Table 1 on page 14, a roller-type pipe stand must be used. The roller-type pipe stand must be capable of handling the weight of the pipe, while allowing the pipe to rotate freely.

1. Ensure that the tool is level. Refer to the “Tool Setup” section for leveling requirements.

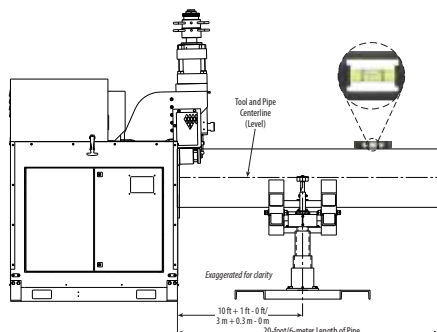

2. Place the pipe stand at a distance slightly beyond half the pipe length from the tool. Refer to the drawing above.

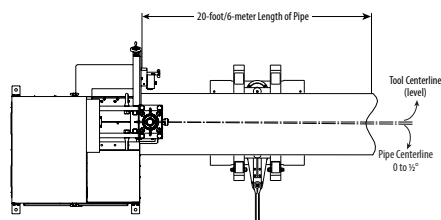

3. Position the pipe stand approximately 0 - 1/2 a degree to the left for the tracking angle. Refer to the drawing above. **NOTE:** When pipe flare is excessive, right-to-left tracking must be kept to a minimum. It may be necessary to use less than 1/2 a degree for the tracking angle.

4. If the tool is properly set up in a level position, but the back end of the pipe is higher than the end being grooved, the pipe may not track. In addition, excessive flare may occur on the pipe end. Refer to the “Tool Setup” section and the drawings above for tool setup and pipe positioning requirements.

5. Before grooving, ensure that all instructions in the previous sections of this manual have been followed.

6. Turn on the main power supply to the tool (main circuit breaker panel, knife switch, etc.).



7. Turn the main power switch on the side of the tool to the **"ON"** position.



9a. Ensure that the selector switch on the control panel is set to the **"GROOVE"** position.

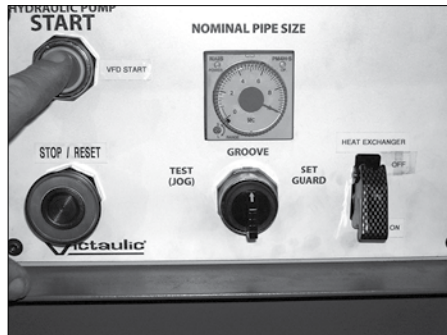
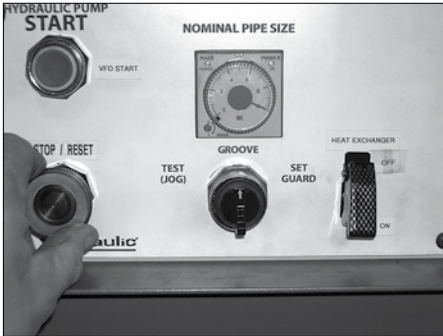

9b. Push the **"HYDRAULIC PUMP START"** button.

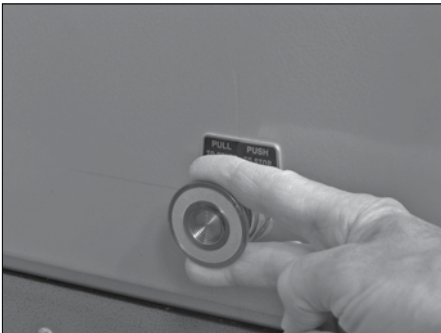

8. Pull the emergency **"STOP"** knob on the control panel and on the electrical enclosure to the out position.

! WARNING

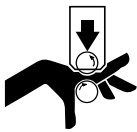

Grooving rolls can crush or cut fingers and hands.

- Always turn off the main power supply to the tool before making any tool adjustments.
- Loading/unloading pipe will place your hands close to the rollers. Keep hands away from the grooving rolls and the roller on the pipe stabilizer during operation.
- Never reach inside the pipe ends or across the tool or pipe during operation.
- Always groove pipe in a **CLOCKWISE** direction.
- Never groove pipe that is shorter than the recommended lengths listed in this manual.
- Never wear loose clothing, loose gloves, or anything that can become entangled in moving parts.



11. The operator should be positioned as shown above.



10. Insert a length of pipe that is the correct size, material, and thickness onto the lower roll. Ensure that the pipe end contacts the lower-roll backstop flange completely. Remove hands from the pipe.



12. To start the grooving operation, depress and hold down the safety foot switch. This will advance the upper roll into contact with the pipe. The lower roll will start rotating, and the groove will begin to form.

13. During the grooving operation, visually check the tracking of the pipe as it rotates. Ensure that the pipe remains against the lower-roll backstop flange. If the pipe does not stay in contact with the lower-roll backstop flange, stop the tool by releasing the safety foot switch, and withdraw foot from the switch. Ensure that pipe is positioned properly (refer to the “Long Pipe Lengths” section). Repeat steps 10–12.



14. As grooving continues, the groove diameter stop will move down and contact the hydraulic cylinder. This contact activates the dwell timer, which allows the pipe to rotate one to three more revolutions to ensure groove completion (refer to the “Dwell Control Adjustment” section). The tool will automatically release the pipe a few seconds later. Release the safety foot switch, and withdraw foot from switch.

15. Inspect the groove/pipe end to ensure that they are within Victaulic specifications.

16. If no more roll grooving will be performed for a while, turn off the hydraulic system by pushing down either the emergency “STOP” knob on the control panel or the one on the electrical enclosure.

NOTICE

- If the pipe remains lodged on the lower roll:
Jogging the lower roll will free the pipe. DO NOT attempt to pull the pipe out of the rolls while “jogging” the lower roll. Pull the emergency “STOP” knob on the control panel to the out position, turn the selector switch to “JOG” mode, then depress the “Hydraulic Pump Start” button.
- The groove diameter must be within specification for the diameter and wall thickness of pipe. The groove diameter should be checked and adjusted, as necessary, to ensure that grooves remain within specification.

NOTICE

- Occasionally during grooving, the groove diameter stop may move up and down slightly, making contact and then breaking contact with the hydraulic cylinder. This is normal for pipe that has a noticeable weld seam or hard spot.
- Ensure that shorter pipe lengths are properly supported.

MAINTENANCE

⚠ DANGER	
	<ul style="list-style-type: none"> • Always turn off the main power supply to the tool before making any tool adjustments or before performing any maintenance.
<p>Failure to follow this instruction could result in death or serious personal injury.</p>	

This section provides information about keeping tools in proper operating condition and guidance for making repairs when it becomes necessary. Preventive maintenance during operation will pay for itself in repair and operating savings.

Replacement parts must be ordered from Victaulic to ensure proper and safe operation of the tool.

LUBRICATION

1. After every 8 hours of operation, lubricate the tool. Always lubricate the upper roll bearings when rolls are changed.

2. Grease the rear bearing. The rear bearing Zerk fitting piping of the VE50T tool includes a valve. This valve must be open while lubricating the rear bearing. The valve must be closed while the VE50T is in operation.

⚠ CAUTION	
<ul style="list-style-type: none"> • Ensure that the rear bearing valve is OPEN while lubricating and CLOSED while the tool is in operation. 	
<p>Failure to follow this instruction could cause tool failure, resulting in personal injury and/or property damage.</p>	

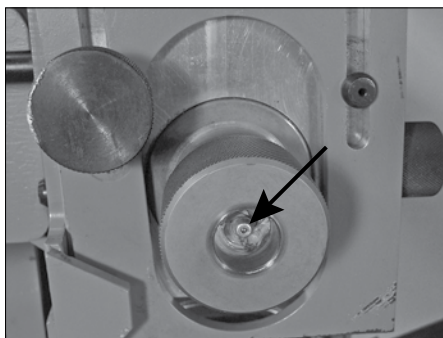

3. Grease the upper shaft bearings every time roll changes are made, and after every 8 hours of operation. A grease fitting is provided on the front of the upper shaft. Refer to the applicable "Recommended Lubricants" table for the proper grease.

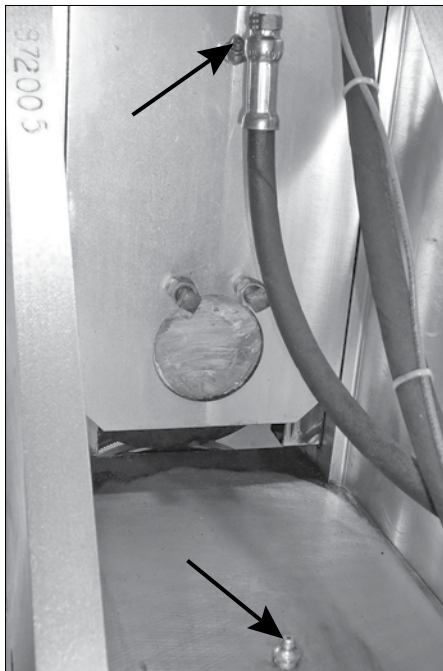

4. Grease the slide gibs and main shaft bearings through the grease fittings located on the back of the slide.

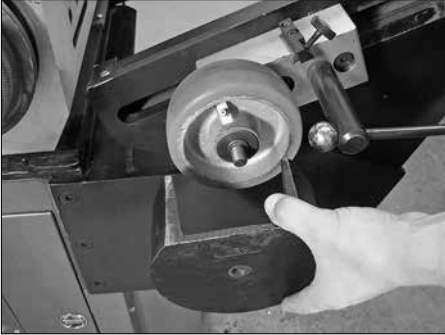
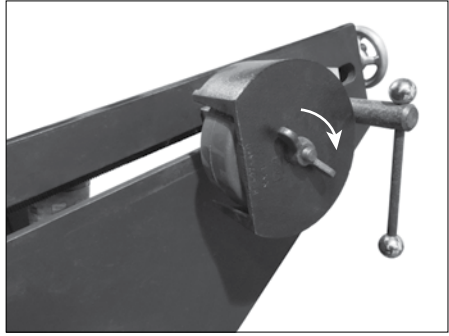
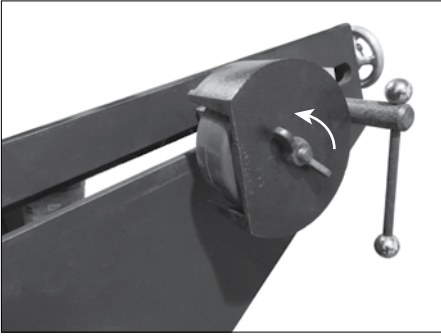

5a. Remove the stabilizer roller guard wing nut and stabilizer roller guard.

5c. Replace the stabilizer roller guard and the stabilizer roller guard wing nut.

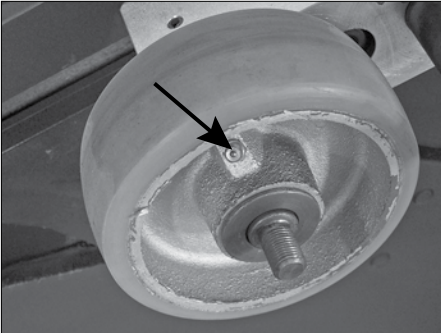





5b. Grease the stabilizer roller.

CHECKING AND FILLING GEAR REDUCER OIL

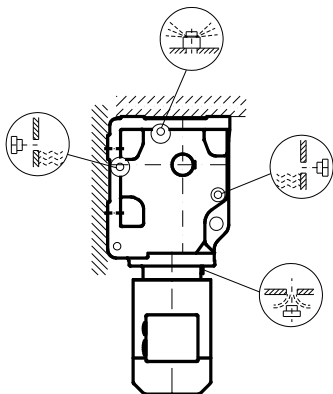
The gear reducer oil level must be checked semi-annually, or every 3,000 hours of operation. If leakage is present, repairs must be made to correct the leak.

1. De-energize the tool and follow proper lockout/tagout procedures.
2. Remove the oil level plug from the gear reducer (refer to drawing below). The oil level should be even with the bottom of the hole.



	Breather Valve
 	Oil Level Plug
	Oil Drain Plug

3. To add oil, remove the plug from the top of the gear reducer and fill to the proper level (refer to drawing above). Refer to the card attached to the gear reducer for the proper lubricant.
4. Re-install the plug(s).

CHECKING AND FILLING HYDRAULIC OIL

1. De-energize the tool and follow proper lockout/tagout procedures.
2. Check the hydraulic oil level on a monthly basis. The level should be 1–2 inches/25–50 mm below the top of the tank. DO NOT overfill the tank, since the oil may overflow due to thermal expansion. Refer to the applicable “Recommended Lubricants” table for the proper hydraulic oil.

REPLACING HYDRAULIC OIL AND FILTER

CAUTION

- Contact Victaulic with any issues related to the VE50T tool’s hydraulic system. Failure to follow this instruction could cause joint failure, resulting in personal injury and/or property damage.

Replace the hydraulic oil and hydraulic oil filter annually or every 2000 hours of operation, whichever comes first.

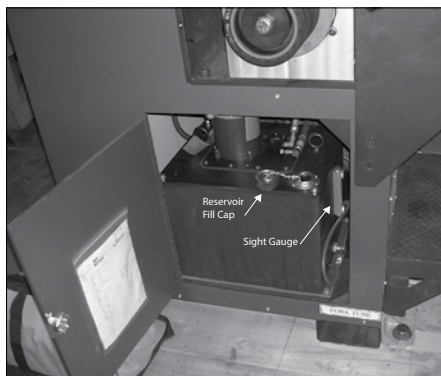

1. Open the storage compartment on the front of the tool cabinet to gain access to the hydraulic oil reservoir and hydraulic oil filter, as shown above.

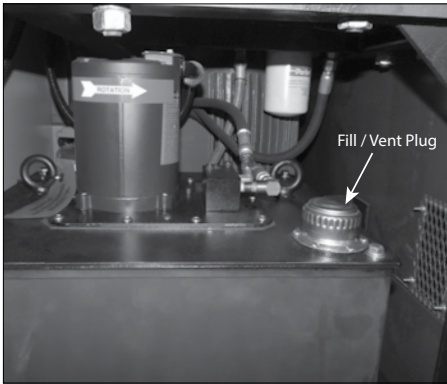

2. Remove the fill/vent plug from the top of the hydraulic oil reservoir.



4a. Place a tray under the hydraulic oil filter. Remove the hydraulic oil filter.

4b. Lubricate the new hydraulic oil filter gasket (shown above) with new hydraulic oil. Fill the filter with new hydraulic oil. Install the new filter hand-tight.

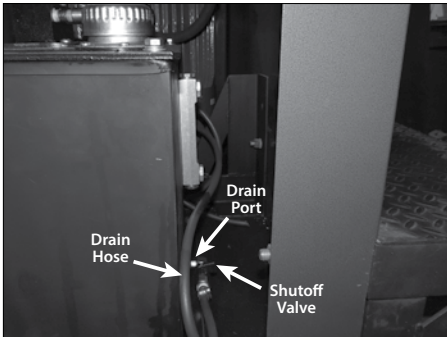

3a. Place the end of the drain hose into a container. Be prepared to drain up to 20 gallons/75 liters of oil.

3b. Open the shutoff valve on the side of the hydraulic oil reservoir to drain the hydraulic oil.

3c. When all hydraulic oil is drained from the hydraulic oil reservoir, close the shutoff valve.

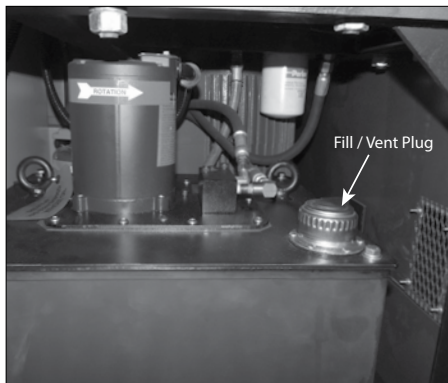

6. Re-install the fill/vent plug into the top of the hydraulic oil reservoir.

7. Turn on the main power supply to the tool (main circuit breaker panel, knife switch, etc.).



8. Turn the main power switch on the side of the tool to the "ON" position.

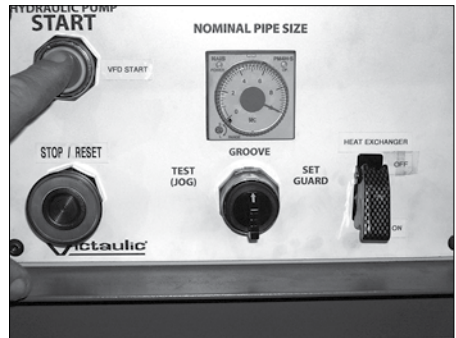

10a. Push the "HYDRAULIC PUMP START" button. Allow the hydraulic pump to run for 3–5 minutes.

10b. Inspect the hydraulic system for leaks.

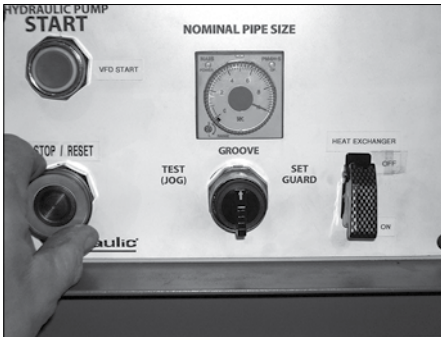

11. Turn off the hydraulic system by pushing down (in) on the emergency "STOP" knob on the control panel.

12. Check the hydraulic oil level. Add oil, as necessary.

13. Follow the "Air Bleeding" section.

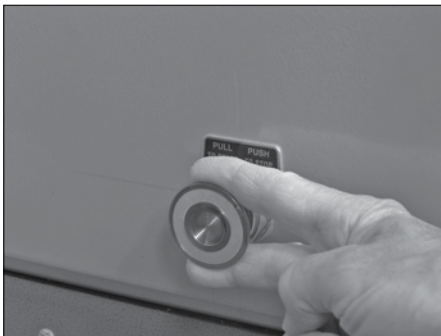

9. Pull the emergency "STOP" knob on the control panel and the electrical enclosure to the out position.

AIR BLEEDING

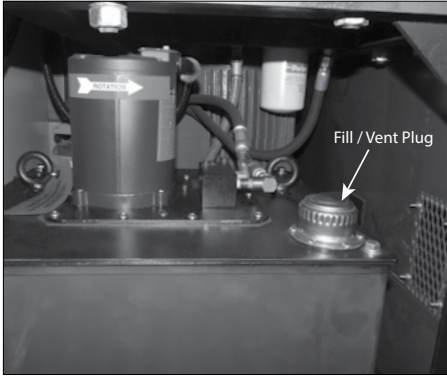

1a. Remove the fill/vent plug from the hydraulic tank.

1b. Add new hydraulic oil to the hydraulic oil reservoir through the fill/vent plug, if necessary. The level should be 1–2 inches/25–50 mm below the top of the tank. Refer to the applicable “Recommended Lubricants” table.

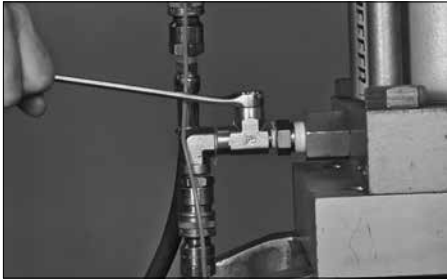

2. Remove the plug from the tee at the bottom of the hydraulic cylinder port.

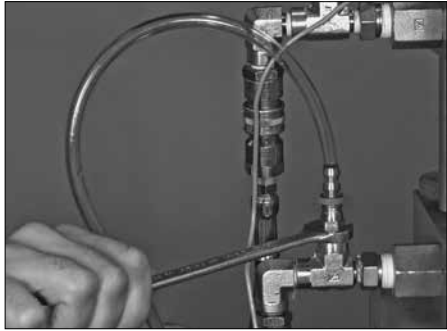

3. Install the bleeder tube into the tee, as shown above. Insert the other end of the bleeder tube into the fill/vent hole in the hydraulic tank.

NOTE: The bleeder tube consists of a ¼-inch NPT barb hose fitting and 4 feet/1.2 m of ¼-inch ID clear vinyl hose (supplied with the tool).

4. Turn on the main power supply to the tool (main circuit breaker panel, knife switch, etc.).



5. Turn the main power switch on the side of the tool to the “ON” position.

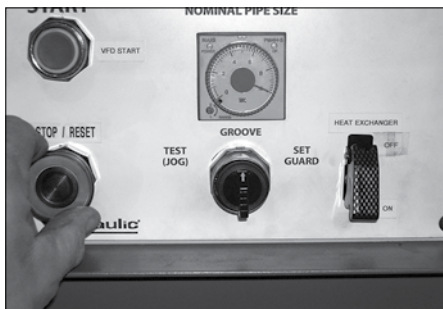

6. Pull the emergency “STOP” knob on the control panel to the out position.

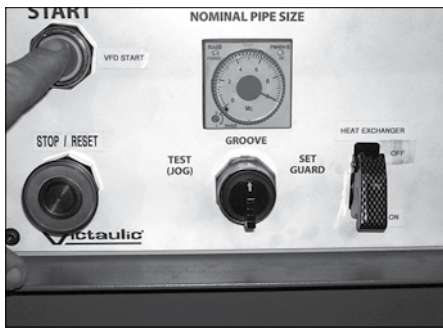

7a. Push the “HYDRAULIC PUMP START” button. Hydraulic oil will start flowing from the tee through the bleeder tube and into the tank.



7b. Place the selector switch on the control panel to the “SET GUARD” mode.

8. Depress the safety foot switch, hold it down for 5 seconds, then release it for 5 seconds. Repeat this step until no air bubbles can be seen through the clear vinyl tube.



9. Push down (in) on the emergency “STOP” knob on the control panel.

NOTICE

- To prevent oil from flowing out of the tee while removing the bleeder tube and installing the plug: Block the groove diameter stop from moving down by inserting a piece of wood between the groove diameter stop and the top of the hydraulic cylinder.

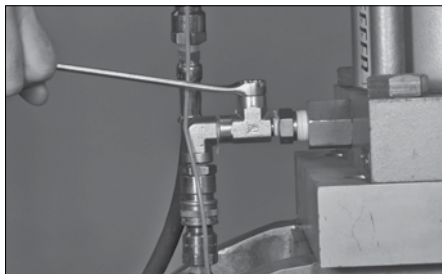

10. Remove the bleeder tube, and install the plug into the tee. **DO NOT ALLOW AIR TO GET BACK INTO THE TEE WHEN INSTALLING THE PLUG (REFER TO NOTICE BELOW).**

NOTICE

- To prevent air from entering the tee while the bleeder tube is removed and the plug is installed: Hold the 4-way valve in the “shifted” position by pressing in on the rubber boot on the end of the valve. Keep the rubber boot depressed until the plug is installed and tightened.

11. Repeat steps 4–11 for bleeding air from the tee at the top of the hydraulic cylinder port.

12. Bring the hydraulic oil level up to 1–2 inches/25–50 mm from the top of the tank. Refer to the applicable “Recommended Lubricants” table for the proper hydraulic oil.

RECOMMENDED LUBRICANTS

BEARING AND SLIDE GREASE – NLGI #2 SUMMER GRADE GRAPHITE MOLY BASE (General Purpose EP Lithium Base Grease)

Manufacturer	Product
BP Amoco	Energrease LC-EP2
Gulf Oil Corp.	Gulfcrown Grease EP#2
Lubriplate	No. 630-2
Mobil Oil Corp.	Mobilux EP2
Pennzoil Products Co.	Pennlith EP 712 Lube
Shell Oil Co.	Alvania EP2
Sun Refining	Sun Prestige 742 EP
Texaco Inc.	Multifak EP2

GEAR OIL

Refer to the tag located on the gear reducer

HYDRAULIC OIL

(High Pressure, Anti-Wear/Anti-Foam Hydraulic Oil ISO Grade 32)

Manufacturer	Product
BP Amoco	Energol HLP-HM32
Gulf Oil Corp.	Harmony 32 AW
Kendall Refining Co.	Kenoil R&O AW-32
Lubriplate	HO-o
Mobil Oil Corp.	Mobil DTE 24
Pennzoil Products Co.	Pennzbell AW32
Shell Oil Co.	Tellus 32
Sun Refining	Survis 832
Texaco Inc	Rando

PARTS ORDERING INFORMATION

Parts can be ordered by calling 1-800-PICK VIC.

When ordering parts, the following information is required for Victaulic to process the order and send the correct part(s).

1. Tool Model Number – VE50T
2. Tool Series Number – 50T002
3. Quantity and Description – For clarification regarding parts, call 1-800-PICK VIC and ask for Engineering Services
4. Where to Send the Part(s) – Company name and address
5. To Whose Attention to Send the Part(s)
6. Purchase Order Number
7. Billing Address

TROUBLESHOOTING

PROBLEM	POSSIBLE CAUSE	SOLUTION
Pipe will not stay in grooving rolls.	Incorrect pipe positioning of long pipe length.	Refer to the "Grooving Long Pipe Lengths" section.
	Lower roll and pipe are not rotating clockwise.	Refer to the "Power Hookup and Verification of Pipe Rotation Direction" section.
Pipe stops rotating during the grooving operation.	Rust or dirt buildup is present on the lower roll.	Remove rust or dirt accumulation from the lower roll with a stiff wire brush.
	Rust or dirt is excessively heavy inside the pipe end.	Remove heavy rust and dirt from inside the pipe end.
	Worn grooving rolls.	Inspect the lower roll for worn knurls. Replace the lower roll if excessive wear is present.
	The circuit breaker has tripped or a fuse has blown out on the electrical circuit that supplies the tool.	Reset the breaker, or replace the fuse.
While grooving, loud squeaks echo through the pipe.	Incorrect pipe support positioning of a long pipe length. Pipe is "over-tracking".	Move the pipe support to the right. Refer to the "Grooving Long Pipe Lengths" section.
	Pipe is not cut squarely.	Cut the pipe end squarely.
	Pipe is rubbing excessively on the lower-roll backstop flange.	Remove the pipe from the tool, then apply a light coating of bandsaw blade wax to the face of the pipe end.
	Ram speed is set too low.	Refer to the "Ram Speed Adjustment" section.
	Tool bearings are not lubricated.	Refer to the "Maintenance" and "Lubrication" sections.
During grooving, loud thumps or bangs occur approximately once every revolution of the pipe.	Pipe has a pronounced weld seam.	For 12-inch/323.9-mm and smaller pipe sizes, raised internal and external weld beads and seams must be ground flush with the pipe surface 2 inches/50 mm back from the pipe ends. For 14 - 38-inch/355.6 - 965-mm pipe sizes, raised internal and external weld beads and seams must be ground flush with the pipe surface 4 inches/100 mm back from the pipe ends. For 40 - 72-inch/1016 - 1829-mm pipe sizes, raised internal and external weld beads and seams must be ground flush with the pipe surface 4 1/2 inches/115 mm back from the pipe ends.
Pipe flare is excessive.	Pipe support is adjusted too high for long pipe.	Refer to the "Grooving Long Pipe Lengths" section.
	Tool is tilted forward (out of level) while grooving long pipe.	Refer to the applicable "Tool Setup" section.
	Incorrect pipe support positioning of long pipe. Pipe is "over-tracking".	Move the pipe support to the right. Refer to the "Grooving Long Pipe Lengths" section.
	Pipe stabilizer is adjusted too far inward.	Back off the pipe stabilizer to the furthest point where it still stabilizes the pipe effectively.
	Ram speed is not set correctly.	Refer to the "Ram Speed Adjustment" section.

TROUBLESHOOTING (CONTINUED)

PROBLEM	POSSIBLE CAUSE	SOLUTION
Larger diameter pipe sways or vibrates from side to side.	Incorrect pipe stabilizer adjustment.	Move the pipe stabilizer in or out until the pipe rotates smoothly.
Tool will not groove the pipe.	Air is present in the hydraulic system.	Refer to the "Air Bleeding" section.
	Pipe is beyond the wall thickness or pipe yield strength capacity of the tool.	Refer to the applicable "Tool Rating and Roll Selection" section.
Pipe groove diameters do not meet Victaulic specifications.	Groove diameter stop is not adjusted properly.	Refer to the "Groove Diameter Stop Adjustments" section.
	Pipe is beyond the wall thickness or pipe yield strength capacity of the tool.	Refer to the applicable "Tool Rating and Roll Selection" section.
	Incorrect upper roll, lower roll, or both installed on the tool.	Install the correct rolls. Refer to the applicable "Tool Rating and Roll Selection" section.
The "A" Gasket Seat or "B" Groove Width dimensions do not meet Victaulic specifications.	Upper roll bearing is not lubricated adequately.	Refer to the "Maintenance" section.
	Incorrect upper roll, lower roll, or both installed on the tool.	Install the correct rolls. Refer to the applicable "Tool Rating and Roll Selection" section.
	Pipe not inserted fully onto the lower roll, or pipe is not tracking properly.	Ensure that pipe is against the lower-roll backstop flange. Refer to the "Grooving Long Pipe Lengths" section for proper pipe stand positioning.

In the event of tool malfunction outside the scope of the troubleshooting section, contact Victaulic Engineering Services for assistance.

EXPLANATION OF CRITICAL ADVANCED GROOVE SYSTEM (AGS) ROLL GROOVE DIMENSIONS

WARNING

- Pipe dimensions and groove dimensions must be within the tolerances specified in the tables on the following pages to ensure proper joint performance.

Failure to follow these specifications could cause joint failure, resulting in serious personal injury and/or property damage.

NOTICE

- Grooving pipe to Advanced Groove System (AGS) specifications enlarges the pipe length by approximately $\frac{1}{8}$ inch (0.125 inch/3.2 mm) for each groove. For a pipe length with an AGS groove at each end, the length will grow approximately $\frac{1}{4}$ inch (0.250 inch/6.4 mm) total. Therefore, the cut length should be adjusted to accommodate this growth. **EXAMPLE:** If you need a 24-inch/610-mm length of pipe that will contain an AGS groove at each end, cut the pipe to a length of 23 $\frac{3}{4}$ inches/603 mm to allow for this growth.
- It is critical to measure the Groove Diameter “C” dimension, along with the Gasket Seat “A” dimension and the Flare Diameter “F” dimension. These measurements must be within the specifications listed in the following tables for proper joint performance.

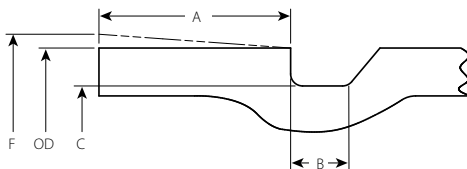

Pipe Outside Diameter – Nominal NPS Pipe Size (ANSI B36.10) and Basic Metric Pipe Size (ISO 4200) – The average pipe outside diameter must not vary from the specifications listed in the following pages (API 5L end tolerance). Maximum allowable pipe ovality shall comply with the requirements of ASTM A-999 and API 5L. Greater variations between the major and minor diameters will result in difficult coupling assembly.

The maximum allowable tolerance from square-cut pipe ends is $\frac{1}{8}$ inch/3.2 mm for all sizes grooved to AGS dimensions. This is measured from the true square line. Any internal and external weld beads or seams must be ground flush to the pipe surface. The inside diameter of the pipe end must be cleaned to remove coarse scale, dirt, and other foreign material that might interfere with or damage grooving rolls. The front edge of the pipe end shall be uniform with no concave/convex surface features that will cause improper grooving roll tracking and result in difficulties during coupling assembly.

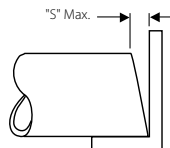

“A” Dimension – The “A” dimension, or the distance from the pipe end to the groove, identifies the gasket seating area. This area must be free from indentations, projections (including weld seams), and roll marks from the pipe end to the groove to ensure a leak-tight seal. All foreign material, such as loose paint, scale, oil, grease, chips, rust, and dirt must be removed.

EXPLANATION OF CRITICAL ADVANCED GROOVE SYSTEM (AGS) ROLL GROOVE DIMENSIONS (CONTINUED)

“B” Dimension – The “B” dimension, or groove width, controls expansion, contraction, and angular deflection of flexible couplings by the distance it is located from the pipe and its width in relation to the coupling housings’ “key” width. The bottom of the groove must be free of all foreign material, such as dirt, chips, rust, and scale that may interfere with proper coupling assembly. The corners at the bottom of the groove must be radiused R.094/R2.39. The Groove Width “B” dimension will be achieved with properly maintained Victaulic tools that are equipped with Victaulic AGS (RW or RWQ) roll sets for carbon steel and standard-wall stainless steel pipe or Victaulic AGS (RWX or RWQX) specifically for light-wall stainless steel pipe.

“C” Dimension – The “C” dimension is the average diameter at the base of the groove. This dimension must be within the diameter’s tolerance and concentric with the OD for proper coupling fit. The groove must be of uniform depth for the entire pipe circumference. Victaulic RW roll sets must be used for carbon steel and standard-wall stainless steel pipe. Victaulic RWX roll sets must be used for light-wall stainless steel pipe.

“D” Dimension – The “D” dimension is the normal depth of the groove and is a reference for a “trial groove” only. Variations in pipe OD affect this dimension and it must be altered, if necessary, to keep the “C” dimension within tolerance. The groove diameter must conform to the “C” dimension described above.

“F” Dimension – Maximum allowable pipe-end flare diameter is measured at the extreme pipe-end diameter. **NOTE:** This applies to average (pi tape) and single-point readings.

Minimum Nominal Wall Thickness – The minimum nominal wall thickness is the lightest grade of pipe that is suitable for cut or roll grooving. Pipe that is less than the minimum nominal wall thickness for cut grooving may be suitable for roll grooving or adapted for Victaulic AGS couplings by using AGS Vic-Ring® Adapters. AGS Vic-Ring Adapters can be used in the following situations (contact Victaulic for details):

- When pipe is less than the minimum nominal wall thickness suitable for roll grooving
- When pipe outside diameter is too large to roll or cut groove
- When pipe is used in abrasive services

For light-wall carbon steel pipe being grooved to AGS specifications (in accordance with EN 10217 or ASTM A-53):

14-inch/355.6-mm minimum nominal wall thickness is 0.220 inch/5.6 mm

16 – 24-inch/406.4 – 610-mm minimum nominal wall thickness is 0.250 inch/6.3 mm

For standard-wall carbon steel pipe being grooved to AGS specifications (in accordance with EN 10217 or ASTM A-53):

14-inch/355.6-mm minimum nominal wall thickness is 0.315 inch/8.0 mm

16-inch/406.4-mm minimum nominal wall thickness is 0.346 inch/8.8 mm

18 – 36-inch/457 – 914-mm minimum nominal wall thickness is 0.375 inch/9.5 mm

For extra-strong carbon steel pipe being grooved to AGS specifications (in accordance with ASTM A-53):

38 – 72-inch/965 – 1829-mm minimum nominal wall thickness is 0.500 inch/12.7 mm

NOTE: For 14 – 72-inch/355.6 – 1829-mm carbon steel pipe being grooved to AGS specifications, the maximum ratings are limited to pipe that does not exceed the yield strength of API-5L Grade “B”, ASTM Grade “B”, 150 Brinell Hardness Number (BHN) maximum.

EXPLANATION OF CRITICAL ADVANCED GROOVE SYSTEM (AGS) ROLL GROOVE DIMENSIONS (CONTINUED)

NOTICE

- Coatings applied to the interior surfaces, including bolt pad mating surfaces, of Victaulic grooved end couplings should not exceed 0.01 inch/0.25 mm. Also, the coating thickness applied to the gasket seating surface and within the groove on the pipe exterior should not exceed 0.01 inch/0.25 mm.
- AGS roll sets for use on both lightwall and standard wall carbon steel pipe are distinguished by a black appearance with a yellow band. AGS roll sets for standard wall only are distinguished by a black appearance with an orange band.
- AGS products require pipe ends that are square cut to within 0.125 inch/3.2 mm. Additionally, the front edge of the pipe end must be uniform, with no concave or convex surface features.

This page intentionally blank

ADVANCED GROOVE SYSTEM (AGS) ROLL GROOVING SPECIFICATIONS FOR CARBON STEEL PIPE

Dimensions – inches/millimeters											
Nominal Size inches mm	Pipe Outside Diameter		Nominal Wall Thickness for Grooving "T"		Gasket Seat "A"		Groove Width "B"	Groove Diameter "C"		Maximum Allowable Flare Diameter "F"	
	Maximum	Minimum	Carbon Steel *†		Maximum	Minimum		Maximum	Minimum		
14	14.093	13.969	0.220-0.750		1.531	1.437	0.455	13.500	13.455	14.23	
350	358.0	354.8	5.6-19.1		38.89	36.50	11.6	342.9	341.8	361.4	
16	16.093	15.969	0.250-0.750		1.531	1.437	0.455	15.500	15.455	16.23	
400	408.8	405.6	6.4-19.1		38.89	36.50	11.6	393.7	392.6	412.2	
18	18.093	17.969	0.250-0.750		1.531	1.437	0.455	17.500	17.455	18.23	
450	459.6	456.4	6.4-19.1		38.89	36.50	11.6	444.5	443.4	463.0	
20	20.093	19.969	0.250-0.750		1.531	1.437	0.455	19.500	19.455	20.23	
500	510.4	507.2	6.4-19.1		38.89	36.50	11.6	495.3	494.2	513.8	
22	22.093	21.969	0.250-0.750		1.531	1.437	0.455	21.500	21.455	22.23	
550	561.2	558.0	6.4-19.1		38.89	36.50	11.6	546.1	545.0	564.6	
24	24.093	23.969	0.250-0.750		1.531	1.437	0.455	23.500	23.455	24.23	
600	612.0	608.8	6.4-19.1		38.89	36.50	11.6	596.9	595.8	615.4	
26	26.063	25.937	0.313-0.750		1.781	1.687	0.535	25.430	25.370	26.30	
650	662.0	658.8	8.0-19.1		45.29	42.90	13.6	645.9	644.4	668.0	
28	28.063	27.937	0.313-0.750		1.781	1.687	0.535	27.430	27.370	28.30	
700	712.8	709.6	8.0-19.1		45.29	42.90	13.6	696.7	695.2	718.8	
30	30.063	29.937	0.313-0.750		1.781	1.687	0.535	29.430	29.370	30.30	
750	763.6	760.4	8.0-19.1		45.29	42.90	13.6	747.5	746.0	769.6	
32	32.063	31.937	0.313-0.750		1.781	1.687	0.535	31.430	31.370	32.30	
800	814.4	811.2	8.0-19.1		45.29	42.90	13.6	798.3	796.8	820.4	
34	34.063	33.937	0.313-0.750		1.781	1.687	0.535	33.430	33.370	34.30	
850	865.2	862.0	8.0-19.1		45.29	42.90	13.6	849.1	847.6	871.2	
36	36.063	35.937	0.313-0.750		1.781	1.687	0.535	35.430	35.370	36.30	
900	916.0	912.8	8.0-19.1		45.29	42.90	13.6	899.9	898.4	922.0	
38	38.063	37.937	0.313-0.750		1.781	1.687	0.535	37.430	37.370	38.30	
950	966.8	963.6	8.0-19.1		45.29	42.90	13.6	950.7	949.2	972.8	

ADVANCED GROOVE SYSTEM (AGS) ROLL GROOVING SPECIFICATIONS FOR CARBON STEEL PIPE (CONTINUED)

Dimensions – inches/millimeters											
Nominal Size inches mm	Pipe Outside Diameter		Nominal Wall Thickness for Grooving "T"		Gasket Seat "A"		Groove Width "B"		Groove Diameter "C"		Maximum Allowable Flare Diameter "D"
	Maximum	Minimum	Carbon Steel *†	Maximum	Minimum	Maximum	Minimum	Maximum	Minimum	Maximum	
40	40.063	39.937	0.313–0.750	2.031	1.937	0.562	0.562	39.379	39.315	40.30	
1000	1017.6	1014.4	8.0–19.1	51.6	49.2	14.3	14.3	1000.1	998.6	1023.6	
42	42.063	41.937	0.313–0.750	2.031	1.937	0.562	0.562	41.375	41.315	42.30	
1050	1068.4	1065.4	8.0–19.1	51.6	49.2	14.3	14.3	1050.9	1049.4	1074.4	
44	44.063	43.937	0.313–0.750	2.031	1.937	0.562	0.562	43.375	43.315	44.30	
1100	1119.2	1116.0	8.0–19.1	51.6	49.2	14.3	14.3	1101.7	1100.2	1125.2	
46	46.063	45.937	0.313–0.750	2.031	1.937	0.562	0.562	45.375	45.315	46.30	
1150	1170.0	1166.8	8.0–19.1	51.6	49.2	14.3	14.3	1152.5	1151.0	1176.0	
48	48.063	47.937	0.313–0.750	2.031	1.937	0.562	0.562	47.375	47.315	48.30	
1200	1220.8	1217.6	8.0–19.1	51.6	49.2	14.3	14.3	1203.3	1201.8	1226.8	
50	50.063	49.937	0.313–0.750	2.031	1.937	0.562	0.562	49.375	49.315	50.30	
1250	1271.6	1268.4	8.0–19.1	51.6	49.2	14.3	14.3	1254.1	1252.6	1277.6	
54	54.063	53.937	0.313–0.750	2.531	2.437	0.562	0.562	53.430	53.370	54.30	
1300	1373.2	1370.0	8.0–19.1	64.3	61.9	14.3	14.3	1357.1	1355.6	1379.2	
56	56.063	55.937	0.313–0.750	2.531	2.437	0.562	0.562	55.430	55.370	56.30	
1400	1424.0	1420.8	8.0–19.1	64.3	61.9	14.3	14.3	1407.9	1406.4	1430.0	
60	60.063	59.937	0.313–0.750	2.531	2.437	0.562	0.562	59.430	59.370	60.30	
500	1525.6	1522.4	8.0–19.1	64.3	61.9	14.3	14.3	1509.5	1508.0	1531.6	
62	62.063	61.937	0.313–0.750	2.531	2.437	0.562	0.562	61.430	61.370	62.30	
1550	1576.4	1573.2	8.0–19.1	64.3	61.9	14.3	14.3	1560.0	1558.0	1582.4	
72	72.063	71.937	0.500–0.750	2.531	2.437	0.562	0.562	71.430	71.370	72.30	
1800	1830.4	1827.2	12.7–19.1	64.3	61.9	14.3	14.3	1814.3	1812.8	1836.4	

* For 26 in/650 mm and larger 0.375–0.500 in/9.5–12.7 mm wall, orange RW or yellow RW striped AGS grooving rolls must be used.

† For 14–24 in/350–600 mm and larger 0.220–0.500 in/5.6–12.7 mm wall, yellow RW striped AGS grooving rolls must be used.

‡ For wall thicknesses outside this range, please contact Victaulic.

VE50T
